

---

**KENDALL COUNTY  
REGIONAL PLANNING COMMISSION**  
111 West Fox Street • Rooms 209 and 210 • Yorkville, IL • 60560  
**AGENDA**

---

Wednesday, July 27, 2016 – 7:00 p.m.

CALL TO ORDER

ROLL CALL: Bill Ashton (Chair), Roger Bledsoe, Tom Casey, Larry Nelson, Vern Poppen, John Shaw, Claire Wilson, Budd Wormley, Angela Zubko and one vacancy (Big Grove Township)

APPROVAL OF AGENDA

APPROVAL OF MINUTES Approval of minutes from the June 22, 2016 meeting

PETITIONS

**1. 16-14 Robert Delaney**

Request: A-1 Special Use  
Location: 16502 Church Road, Lisbon Township  
Purpose: Request for approval of an A-1 Special Use to operate an outdoor shooting range

**2. 16-16 Chris and Megan Jensen**

Request: A-1 Special Use  
Location: 7225 Caton Farm Road, Kendall Township  
Purpose: Request for approval of an A-1 Special Use to operate a landscape and excavation business

REVIEW OF PETITIONS THAT WENT TO COUNTY BOARD

16-09 – Whitetail Ridge LLC – A-1 Special Use – Banquet Hall Facility – 9111 Ashley Road, Kendall Township – Approved by County Board 7.19.16

CITIZENS TO BE HEARD/PUBLIC COMMENT

NEW BUSINESS

OLD BUSINESS

Review and Discussion of LRMP – NW corner of Light Road and Route 31  
Dumpsters in Residential Zoning Districts

ADJOURNMENT

Next Regularly Scheduled Meeting – Wednesday, August 24, 2016 at 7:00pm

**KENDALL COUNTY  
REGIONAL PLANNING COMMISSION**

*Kendall County Office Building  
Rooms 209 & 210  
111 W. Fox Street, Yorkville, Illinois*

**Unofficial Meeting Minutes of June 22, 2016**

Chairman Bill Ashton called the meeting to order at 7:00 pm.

**ROLL CALL**

Members Present: Bill Ashton, Vern Poppen, Budd Wormley, Larry Nelson, Roger Bledsoe, Angela Zubko

Staff present: John Sterrett, Senior Planner

Members Absent: John Shaw, Tom Casey, Claire Wilson

In the Audience: Attorney Dan Kramer; Ron Walker; Dave Walker; Attorney Gregg Ingemunson; Tom Schnabel, Jr.; Vicky Schnabel; Susan Munson

**APPROVAL OF AGENDA**

Mr. Wormley made a motion, seconded by Ms. Zubko, to approve the agenda as written. With a voice vote of all ayes, the motion carried.

**APPROVAL OF MINUTES**

Mr. Wormley made a motion, seconded by Mr. Poppen, to approve the May 22, 2016 regular meeting minutes with a correction regarding a typo in the petition section. With a voice vote of all ayes, the motion carried.

**PETITIONS**

**16-10 Whitetail Ridge, LLC**

**Request:** Special Use to allow a banquet facility

**Location:** 9111 Ashley Road in Fox Township

Mr. Sterrett stated that this petition was continued from last month's Plan Commission meeting pending a review and recommendation from the Kendall Township Board. The petition is a request for a special use in the A-1 Agricultural to operate a banquet facility at 9111 Ashley Road in Fox Township. The Township Board had their meeting on June 21, 2016 and voted 3-2 to recommend approval of the petition with the following recommendations:

1. Install evergreen trees north of the building to screen the property from the property across the street and to reduce noise from leaving the property
2. Construct a berm along Ashley Road to provide additional screening and noise reduction
3. Adequate lighting be installed
4. Strict enforcement of hours of operation

Staff has recommended the following conditions be placed on the special use ordinance:

1. The property shall be developed in substantial compliance with the submitted site
2. A change of occupancy permit shall be secured for all buildings associated with the banquet facility use prior to events occurring on site
3. The maximum number of patrons for events shall be limited to 280, including any vendors working on the property for an event
4. No alcohol shall be sold at retail on the property and all regulations of the Kendall County Liquor Control Ordinance shall be followed
5. Food shall be provided only by licensed caterers
6. A maximum of eight (8) employees

7. All events shall end no later than 12:00am
8. Lighting shall comply with Section 11 02.F.12 of the Zoning Ordinance
9. Parking reserved for ADA accessibility shall be marked and constructed with a hard surface
10. The banquet facility shall conform to the regulations of the Kendall County Health Department
11. Retail sales are permitted provided that the retail sales will be ancillary to the main operation and such sales occur only during an event
12. One (1) sign, either a wall sign or a free-standing sign, shall be permitted on the property and shall comply with the sign requirements of Section 12 of the Kendall County Zoning Ordinance.
13. Noise regulations are as follows:

Day Hours: No person shall cause or allow the emission of sound during daytime hours (7:00 A.M. to 10:00 P.M.) from any noise source to any receiving residential land which exceeds sixty five (65) dBA when measured at any point within such receiving residential land, provided; however, that point of measurement shall be on the property line of the complainant.

Night Hours: No person shall cause or allow the emission of sound during nighttime hours (10:00 P.M. to 7:00 A.M.) from any noise source to any receiving residential land which exceeds fifty five (55) dBA when measured at any point within such receiving residential land provided; however, that point of measurement shall be on the property line of the complainant.

**Exemption:** Powered Equipment: Powered equipment, such as lawn mowers, small lawn and garden tools, riding tractors, and snow removal equipment which is necessary for the maintenance of property is exempted from the noise regulations between the hours of seven o'clock (7:00) A.M. and ten o'clock (10:00) P.M.

Attorney Dan Kramer representing the petitioner, Whitetail Ridge Golf Club LLC, reviewed the proposed banquet facility and explained the operation and proposed site plan. The existing buildings will be utilized for the operation with no new buildings proposed. Mr. Kramer commented on the recommendations from the Township and that they are fine with those recommendations. Mr. Kramer discussed previous banquet facilities that have been approved with similar surrounding settings. The Right-to-Farm clause has been requested to be included in the approving ordinance by one of the nearby property owners. Liquor would not be sold at the subject property. Gregg Ingemunson, attorney for Tom and Vicky Schnabel who live directly across the street, spoke about how the proposed use is a commercial operation that conflicts with the surrounding agricultural properties and spoke of potential negative impacts. Tom Schnabel lives directly across the street and stated that the noise will travel easily from the subject property to his. Mr. Schnabel also raised a concern over multiple events each day. Vicky Schnabel also raised concerns over multiple events taking place in one day on the subject property and the negative impacts. Susan Munson lives around the corner from the subject property on Walker Road stated that she does not believe this type of commercial use is a good fit within the agricultural area. Mr. Kramer addressed the comments from the nearby property owners and spoke of the petitioner's experience operating a banquet facility. The Commission discussed the proposed use and if it fits with the surrounding agriculture area. Claire Wilson of the Plan Commission could not attend but submitted written comments that were read aloud voicing her concerns regarding the proposed use including the noise.

Mr. Bledsoe made a motion, seconded by Ms. Zubko, to recommend approval of the petition with the conditions recommend by staff as well as the recommended conditions from the Township, that the right-to-farm clause be included in the controlling special use ordinance, and that no music shall occur outside, with the exception of processional music for wedding ceremonies.

Mr. Sterrett called the roll: Mr. Bledsoe-No; Ms. Zubko-No; Mr. Nelson-No; Mr. Ashton-No; Mr. Wormley-No; Mr. Poppen-No. The motion failed 0-6.

Mr. Sterrett stated that this petition will move onto the Special Use Hearing Officer on Thursday, July 7<sup>th</sup> at 7:00pm.

## **REVIEW OF PETITIONS THAT WENT TO COUNTY BOARD**

16-09 – Joe Gomoll – A-1 Special Use – Production and sale of items produced both on site and off site as well as ancillary items – 10151 Lisbon Road, Fox Township – County Board Agenda 6.21.16

## **CITIZENS TO BE HEARD/ PUBLIC COMMENT**

None

## **NEW BUSINESS**

### **Review and Discussion of LRMP – NW corner of Light Road and Route 31**

The Kendall County Planning, Building, and Zoning Department was approached by a property owner located at the northwest corner of State Route 31 and Light Road regarding a proposed expansion of an existing indoor self-service storage facility. The expansion would consist of the construction of a 8,400sf self-service storage building as well as a proposed outdoor storage area. The existing facility is zoned as B-2 (General Business) with a special use to operate the indoor self-service storage facility. The special use was granted for the indoor self-service storage facility in 1976. The parcel immediately to the south of the existing facility, where the expansion is proposed, is zoned as B-1 (Local Shopping). The B-1 district does not permit indoor self-service storage facilities nor does it allow outdoor storage either by right or by special use. The B-2 district allows for an indoor self-service storage facility as a conditional use and allows for outdoor storage as a special use. The property owner therefore will need to seek a rezoning of the current B-1 zoned property to B-2 for this expansion.

When reviewing proposed zoning map amendments, the County's Land Use Plan is taken into consideration to determine the proper zoning and uses for a specific area. The County's Land Use Plan currently identifies the subject area at the northwest corner of State Route 31 and Light Road as suburban residential (max density 1.00 du/acre). The existing zoning in the subject area consists of a mix of commercial zoning: B-1 (Local Shopping), B-2 (General Business), B-3 (Highway Commercial) with the existing uses of a gas station, a commercial strip mall, the self-service storage facility, a decommissioned water treatment facility, and stormwater detention facilities to serve these commercial uses. The area totals 10.5 acres.

The Plan Commission stated that this area should be changed to commercial to reflect the existing zoning and land uses at the area. Staff will prepare a draft amendment to the Land Use Plan for this area and bring it back to the Plan Commission for review. A public hearing will then need to be scheduled following that review.

## **OLD BUSINESS**

Dumpsters in Residential Zoning Districts – continued.

## **ADJOURNMENT**

Ms. Zubko made a motion, seconded by Mr. Poppen, to adjourn. With a voice vote of all ayes, the motion carried. The Regional Plan Commission meeting adjourned at 8:04 pm.

Respectfully submitted by,  
John H. Sterrett, Senior Planner

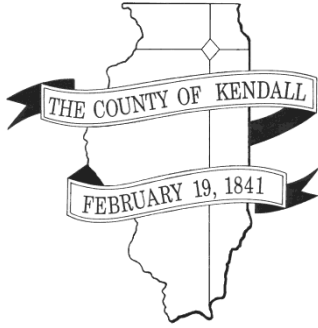

**DEPARTMENT OF PLANNING, BUILDING & ZONING**

111 West Fox Street • Room 203

Yorkville, IL • 60560

(630) 553-4141

Fax (630) 553-4179

**Petition 16-16**

**Robert Delaney**

**A-1 Special Use – Outdoor Shooting Range**

**SITE INFORMATION**

PETITIONER Robert Delaney

ADDRESS 16502 Church Road

LOCATION East side of Church Rd; 0.25 mi north of Whitewillow Road



TOWNSHIP Lisbon

PARCEL # 08-25-300-009; -006

LOT SIZE 38.49 acres

EXITING LAND USE Agricultural

ZONING A-1 Agricultural District

LRMP	Land Use	Agricultural
	Roads	Church Road is a township road classified as a non-Collector Road
	Trails	None

Floodplain/ Wetlands	Fresh water emergent wetlands exist on the northwest portion of the property
-------------------------	--

REQUESTED ACTION: A-1 Special Use to operate an outdoor shooting range

APPLICABLE REGULATIONS: Section 7.01 D.33 – A-1 Special Uses – Permits Outdoor Shooting and Target Practice to be located in the A-1 District with approval of a Special Use provided that certain requirements are met.

Section 13.08 – Special Use Procedures

**SURROUNDING LAND USE**

Location	Adjacent Land Use	Adjacent Zoning	Land Resource Management Plan	Zoning within 1/2 Mile
North	Agricultural	A-1	Agricultural	A-1
South	Agricultural	A-1	Agricultural	A-1
East	Agricultural/ComEd Transmission Lines	A-1	Agricultural	A-1
West	Agricultural/Residential	A-1	Agricultural	A-1

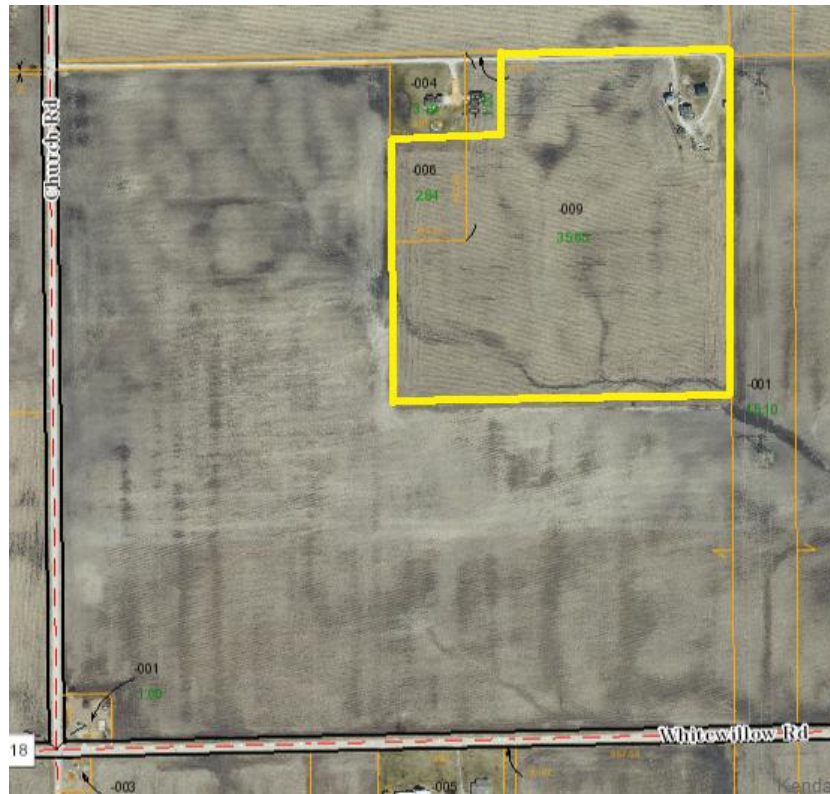

**PHYSICAL DATA**

**ENDANGERED SPECIES REPORT**

No Endangered or Threatened Species identified in the vicinity of the project area. Consultation is terminated

**NATURAL RESOURCES INVENTORY**

The Kendall County Soil & Water Conservation District is preparing an NRI Executive Report to be submitted to the Planning, Building, and Zoning Department once completed.

## **ACTION SUMMARY**

### **LISBON TOWNSHIP**

It is the understanding of that a special Township Plan Commission meeting and a special Township Board meeting to discuss the proposed special use request will occur prior to the Kendall County Regional Plan Commission meeting.

### **ZPAC (7.12.16)**

Questions from the ZPAC committee were raised regarding the existing easement for ingress and egress for the site onto Church Road. The Health Department requested meeting with the petitioner to go over the requirements for well, septic, and food sanitation to ensure all applicable health department codes are being met. Issues on drainage and lead abatement were discussed and how these items will be handled including the required Stormwater Management Permit and the submittal of a hazardous waste plan to address lead removal on the property.

The ZPAC forwarded the petition onto the Kendall County Regional Plan Commission with a favorable recommendation.

## **GENERAL**

Robert Delaney is requesting an A-1 Special Use to operate an outdoor shooting range at the subject property. This type of use is permitted as a special use on an A-1 property with certain conditions. Those conditions include:

- a. Requires conformity with NRA standards; provide appropriate berming based on surrounding land use and type(s) of firearms to be used. Such as berming shall generally be consistent with standards established in the NRA Source Book.
- b. Requires minimum parcel size of 5 acres, depending on the venue.
- c. Must have a sign that lists allowed firearm types, rules of operation; hearing and vision protection required.
- d. State recognized, nationally recognized or NRA Certified range supervisor must be present
- e. Range flag flown, a sign or red light lit at all times that firing is taking place.
- f. Hours and days of operation as specified in the Special Use Permit to be determined by the County Board.
- g. Access must be controlled by a lockable gate.
- h. Hazardous waste plan addressing lead management required.
- i. No discharge of lead shot into wetland.
- j. Must be at least 1,000' from existing dwellings and property lines of schools, daycares, places of worship and airstrips.
- k. No alcohol allowed.
- l. No projectiles shall leave the boundaries of the site.
- m. All applicable Federal, State and County rules and regulations shall be adhered to.
- n. Must meet all requirements of the Kendall County Health Department
- o. Water and drainage plans must be approved by the Kendall County Planning, Building and Zoning Office.
- p. Signage is permitted but must meet the Sign Ordinance regulations of Section 12 of the Zoning Ordinance.
- q. Lighting shall meet the standards of Section 11.02.F.12.d of the Zoning Ordinance.
- r. Must adhere to the Performance standards of Section 10.01.F of the Zoning Ordinance

## **RANGE LAYOUT**

The petitioner has submitted an exhibit depicting a distance of at least 1,000' from the southeastern corner of the nearest residential dwelling unit to the west of the proposed range. Two (2) shooting bays are proposed each containing twenty-four (24) shooting lanes with a distance of seventy-five (75) feet. The range has a north-south orientation with the firing taking place towards the south. A ten (10) foot high precast concrete divider/impact wall will be located on the east and west side of the bays with the same type of wall dividing the bays. A covered/overhead baffled shooting structure is proposed for the shooting bay on the eastern side of the property closest to the ComEd right-of-way. A sixty-four (64) foot wide earthen berm is proposed to serve as a backstop for the range as well as side-berming on the western portion of the range. The berm is proposed to be twenty (20) feet in height on all sides and at the peak will have a flat portion of four (4) feet

containing a six (6) foot vertical wood baffle. The distance from the edge of the backside of the backstop berm to the limits of the property is approximately 850'.

#### **BUSINESS NARRATIVE**

The petitioner has submitted a business plan outlining activities. The hours of operation are proposed to be Tuesday thru Friday 10:00am to 8:00pm or until one-half hour before dusk, whichever is first, and Saturday and Sundays 9:00am to 8:00pm or until one-half hour before dusk, whichever is first. The petitioner has indicated that the Sunday hours will be modified to open later than the originally proposed 9:00am start time. The range will be closed on Mondays. The petitioner has indicated that one (1) range safety official will be assigned for each twelve (12) lanes with a chief range safety officer on-site to oversee all range bays.

#### **LEAD MANAGEMENT**

A hazardous waste plan addressing lead management is required for outdoor shooting ranges. This plan has not been submitted and the petitioner has indicated they are working with an outfit to provide screening of the area for lead removal. This plan is a required document as part of the special use.

#### **HEALTH CODES**

The petitioner is proposing to use one portable toilets for on site on a temporary basis until a future building is constructed to accommodate restroom facilities. The petitioner has been in contact with the Health Department to secure all necessary permits related to well, septic, and food vendors.

#### **BUILDING CODES**

A temporary range building with electric service is proposed. This building will need to be evaluated by the Building Department for determination of any required building permits. A future building is proposed to serve as a check-in facility. This building will require a building permit.

#### **ACCESS**

The property is a landlocked parcel without direct access onto Church Road. The petitioner has indicated that access to Church Road is obtained through an easement agreement for ingress and egress with property to the west of the subject parcel utilizing a private gravel drive that serves the residential dwelling unit on the property to the west of the subject parcel. The petitioner has indicated future intention of improving the gravel drive with tar and chip.

#### **PARKING**

The site plan identifies thirty-eight (38) parking stalls with two (2) of these as reserved for ADA compliance. The Zoning Ordinance does not require a certain number of parking stalls for a use such as a shooting range. The NRA Range Source book, however, does recommend 1.5 parking stalls per shooting lane. The location and dimensions of these parking stalls meet the requirements of setbacks and width and depth.

#### **LANDSCAPING**

The petitioner is proposing twelve (12) evergreen trees to be planted on the western portion of the operation.

#### **LIGHTING**

The petitioner has indicated that security lighting may be added around building and security gate. Staff recommends a requirement for this lighting be shrouded to prevent glare onto adjacent properties.

#### **SIGNAGE**

Two (2) off-premises directional signs are proposed with one located at the northeast corner of the private drive and Church Road and one located at the southeast corner of Route 52 and Church Road. Off-premise signs are not permitted in the A-1 Agricultural District.

#### **CONCLUSION**

The proposed use of the property for an outdoor shooting range is considered permitted as a special use in the A-1 District with several required conditions outlined above including conformance with the standards of the NRA Range Source Book. Other conditions should be considered to mitigate any potential negative impacts an outdoor shooting range may have on surrounding properties and to address any potential environmental concerns with regards to lead. This includes the submission of a hazardous waste plan addressing lead management using the EPA Best Management Practices for Lead at Outdoor Shooting



Range. Additional safety measures are being considered to prevent any projectiles leaving the boundaries of the site onto adjacent properties including an increase in height of the proposed berm to twenty (20) feet per the NRA Source Book and the installation of barriers designed to contain, deflect or fragment bullets to prevent any projectiles from leaving the range area.

## **RECOMMENDATION**

If approved, staff recommends the following conditions be placed on the controlling special use, as well as any other conditions identified by the Regional Plan Commission:

- The shooting range operation shall conform with NRA standards established in the NRA Source Book
- Berming shall be a minimum height of twenty (20) feet per the NRA Range Source Book
- A sign shall be installed that is visible to all visitors of the shooting range that lists allowed firearm types, rules of operation – hearing and vision protection required
- The existing gravel drive providing access from Church Road to the site be improved with a hard surface
- A State recognized, nationally recognized or NRA Certified range supervisor shall be present at all times
- A range flag, a sign, or red light shall be displayed at all times when firing is taking place
- Access to the shooting range shall be controlled by a lockable gate.
- Hazardous waste plan addressing lead management required with a lead removal occurring at least once a year
- Submission of a maintenance bond annually for removal of lead
- Submission of the types of firearms to be used
- Only the use of handguns shall be permitted and no high power rifles or shotguns shall be permitted
- No discharge of lead shall occur into any wetlands
- No alcohol shall be allowed
- Sunday hours of operation shall be limited to 12:00pm to 8:00pm, or until one-half hour before dusk
- A sheltered canopy structure shall be constructed to serve as a baffle for the range to prevent any projectiles from leaving the range area or exceeding the height of the twenty (20) foot berm. This design shall be submitted to the Kendall County Planning, Building, and Zoning Department for review and approval.
- All applicable Federal, State and County rules and regulations shall be adhered to
- All applicable Federal and State licenses and approval shall be submitted to the Kendall County Planning, Building, and Zoning Department prior to commencing operations and submitted annually thereafter
- Shall satisfy all requirements of the Kendall County Health Department
- A stormwater management permit shall be approved prior to the start of construction
- Proposed signage shall meet the requirements of Section 12 of the Zoning Ordinance
- Lighting shall meet the standards of Section 11.02.F.12.d of the Zoning Ordinance
- Must adhere to the Performance standards of Section 10.01.F of the Zoning Ordinance

## **ATTACHMENTS**

1. Description of proposed use - prepared by the petitioners
2. ZPAC Minutes – 7.12.16
3. Site Plan Drawings

**"DIRT ROAD RANGE"**  
Operations Proposal

- Hours of ops: 0900--½ hour before dusk, 6 days/week (7th day for maintenance)
  - Hours: Tues-Fri 1000 to 2000 OR ½ hr before dusk, whichever is first, Sat & Sun is 0900 to 2000 OR ½ hr before dusk, Mon closed
    - Online calendar will refer to Almanac for sunset time
    - Options available to rent portion or all of range
    - Reserve 2 lanes for private lessons
    - Have guns available for rental and ammo for sale
      - Will require amended (add) address for FFA license
    - Host regular and special events
      - i.e. Tuesday night steel or have special guest instructor
- Main concern is education & safety while providing a facility that will be available to the shooting public and LEO's + FFD's
  - Membership available for additional benefits
    - Discounted range fees (1/2 price)
    - Discount on ammo, training (10%) + free membership to CRA
    - Annual fee at \$360
    - Weekdays: unlimited time, Weekends: 2 hour limit
    - Free shirt (contests for wearing shirt and posting on social media: maybe entered into raffle?)
    - Member appreciation days (guest instructors, guests, scenarios)
    - Multi-level? I.e. Gold vs Bronze
  - Food truck on site
    - Trucks pay for privilege of being on site (\$50/hour or \$250/day) Auction Sale %
    - Available during peak hours
    - Multiple trucks can be scheduled (they need permit from Kendall County)
  - Porta-potty Rental
    - Typically \$100-\$200/month (includes weekly maintenance)
    - May use one at first with multiple units with growth
- Scheduling by the shooters will be over an internet site that enables the participant to check on availability and self-schedule
  - Calendar options are Square, Bizzflo, as well as our current merchant processing system candidate (which offers a calendar scheduling app)
    - Other options: BookSimple, Booker
  - Some lanes will be designated for reservations and others left available for walk-ins (not listed on calendar site)
    - Ratio can change for peak times (accommodate for more walk-ins during busiest hours)
  - Website designed and optimized by CDG contactors
- Range mgmt will be conducted to the highest level of safety and comfort, range officials will be certified and are in full control of all Range Activities.
  - First Aid & CPR Cert for all EEs
  - Need to create in-house training for all range EEs that would reiterate NRA and any additional standards created by us

? \$ hourly rate

**"DIRT ROAD RANGE"**  
**Operations Proposal**

- All 1<sup>st</sup> time shooters required to watch safety video (this is currently not standard for any known range), and annually for repeat customers
  - CDG will track safety video requirement electronically
  - Safety video will be produced by CDG contractors
- This is a new concept to our shooting community and will provide the best use for this isolated parcel
- LEO's will be able to use the range at their convenience at no charge *FFDO's*
  - Might be better to offer LEO/VET get ½ price on range fees—no other ranges in area offer totally free fees to LEO/VET's and few offer ½ price. This would still make us competitive.
  - VET and LEO get ½ price on membership (plus 1st time free) *FFDO's*
- We are thinking the total initial number of employees full-time and part-time at 10-12
  - 1 range safety per 12 lanes. Plus DR running the office. On weekends or peak times 1 or 2 additional personnel to assist with register and sales
    - Ex: 36 lanes on Saturday -- 6 persons total. 3 safety and 3 in office. Certain employees could rotate in office and on range duties
    - DR or JV to handle any transactions that need to be taken to Tom's for FFA (i.e.: any gun sales)
  - Reduce required RSO's by requiring 1st time shooters to watch 10-15 minute safety video (no direct competitor is doing this, but it is common in other industries such as skydiving, paintball and go karting).
- Sales of items to enhance safety will include safety glasses, ear plugs, ear muffs, bottled water and assorted non-alcoholic canned or bottled water and sodas.
  - We found out that FFA can't do business on the site for guns (until address change is registered with ATF), but all the non-firearm stuff is good to go
  - We could advertise for FFA's gun inventory on site, but buyers would have to physically travel to 14207 to actually transact any sales
- Operations on a daily basis will be managed and operated by CDG, a highly qualified group of Veterans of the Iraq and Afghanistan conflicts
- CDG will manage the range on a daily basis, with staff that is certified range management
  - Lighting, for security reasons, may be placed around office and gate on a timer. JV & DR to handle all end of shift procedures. Including lock-up and security of money.

**ZONING, PLATTING & ADVISORY COMMITTEE (ZPAC)  
July 12, 2016 – Meeting Minutes**

**Unofficial until Approved**

Senior Planner John Sterrett called the meeting to order at 9:00 a.m.

Present:

Scott Gryder – PBZ Committee Chair  
Fran Klaas – Highway Department  
David Guritz- Forest Preserve  
Commander Mike Peters – Sheriff's Office  
Aaron Rybski – Health Department  
Greg Chismark – WBK Engineering, LLC  
Brian Holdiman- PBZ Department  
Megan Andrews – Soil & Water Conservation District  
John Sterrett – PBZ Department

Absent: None

Audience: Attorney Dan Kramer; Robert Delaney; Jamie Bradley; David Renick

**AGENDA**

Mr. Gryder made a motion, seconded by Mr. Klaas, to approve the agenda as written. With a voice vote of all ayes the motion carried.

**MINUTES**

Mr. Guritz made a motion, seconded by Mr. Gryder, to approve the May 3, 2016 meeting minutes as written. With a voice vote of all ayes the motion carried.

**PETITIONS**

**#16-14 – Robert Delaney**

Mr. Sterrett outlined the request for a special use in the A-1 Agricultural District to operate an outdoor shooting range, which is permitted as a special use in the A-1 Agricultural District with certain requirements. The property is located at 16502 Church Road in Lisbon Township. The property is just under 40 acres. The petitioner has submitted a business narrative to the PBZ Department including proposing twenty-four (24) shooting lanes with twelve (12) future lanes. The proposed range is located on the far eastern portion of the property, just west of the existing ComED right-of-way. Thirty-six (36) parking stalls are proposed for the use. Although the County's Zoning Ordinance does not have a specific requirement for the number of parking stalls for an outdoor shooting range, the NRA Range Source book recommends at least 1.5 parking stalls for each shooting lane. The Zoning Ordinance requires that a 1,000' buffer is maintained between a shooting range and any residential dwelling units. The petitioner has submitted an exhibit that depicts 1,000' from the edge of the shooting range to the southeast corner of the nearest residential dwelling unit. The property is landlocked and does not have direct access onto Church Road. The petitioner has indicated that an easement for ingress and egress exists with the property owner to the west to obtain access on an gravel existing drive to Church Road. Staff has a series of conditions that are recommended primarily dealing with NRA standards. The conditions include:

- The shooting range operation shall conform with NRA standards established in the NRA Source Book
- Berming shall be a minimum height of twenty (20) feet per the NRA Range Source Book
- A sign shall be installed that is visible to all visitors of the shooting range that lists allowed firearm types, rules of operation – hearing and vision protection required
- A State recognized, nationally recognized or NRA Certified range supervisor shall be present at all times
- A range flag, a sign, or red light shall be displayed at all times when firing is taking place
- Access to the shooting range shall be controlled by a lockable gate.
- Hazardous waste plan addressing lead management required with a lead removal occurring at least once a year
- Submission of a maintenance bond annually for removal of lead
- Submission of the types of firearms to be used
- No discharge of lead shall occur into any wetlands

- No alcohol shall be allowed
- Sunday hours of operation shall be limited to 12:00pm to 8:00pm, or until one-half hour before dusk
- Baffles shall be installed to prevent projectiles from leaving the boundaries of the site
- All applicable Federal, State and County rules and regulations shall be adhered to
- Must meet all requirements of the Kendall County Health Department
- A stormwater management permit shall be approved prior to the start of construction
- Proposed signage shall meet the requirements of Section 12 of the Zoning Ordinance
- Lighting shall meet the standards of Section 11.02.F.12.d of the Zoning Ordinance
- Must adhere to the Performance standards of Section 10.01.F of the Zoning Ordinance

Attorney Dan Kramer, representing the petitioner, stated that the easement for the access onto Church Road is binding on all successors, heirs, and assigns and is a covenant running with the land. The engineer for the petitioner, Jamie Bradley, explained the layout of the proposed use including the gravel parking area and using portable toilets on the property. Mr. Bradley stated that as a future endeavor a building may be constructed to serve a check-in facility with restrooms. Mr. Bradley stated the range will be used for handguns. Mr. Bradley stated that stormwater management will be developed to address a future building on the site. Aaron Rybski of the Health Department asked about plans to develop septic facilities and stated that portable toilets are not best for long term use. Mr. Rybski stated that there is a non-community water well program that is applicable when a use has at least 25 patrons for 60 days each calendar year. Mr. Rybski suggested that the petitioner meet with the Health Department to discuss the requirements for well and septic as well as the possibility of using food trucks on site. David Guritz of the Forest Preserve District asked about the abatement of lead on the property. Mr. Sterrett stated that the Zoning Ordinance requires a hazardous waste plan addressing lead management be submitted. Staff is suggesting that in addition to this, there be a requirement that the property is screened of lead at least once a year and that a maintenance bond be submitted on an annual basis for lead removal. Megan Andrews of the Kendall County Soil and Water Conservation District (KCSWCD) asked about the type of berm that will be built. Mr. Bradley stated it will be an earthen berm. The KCSWCD will be doing an NRI Executive Report on the project.

Mr. Delaney elaborated on the use of portable toilets and that he anticipates they will be used on a short term basis. Mr. Delaney also stated that the hours of operation will be shortened on Sundays. Mr. Delaney indicated that he has been in contact with the Kendall County Sheriff's Office about the possible use of the range for the Sherriff's Office. Mr. Delaney stated that to address baffles, a sheltered structure can be constructed where the shooters are located to prevent projectiles from obtaining a trajectory that will leave the limits of the range. Mr. Gryder asked if concealed carry classes would be offered at the site. Mr. Delaney stated that it is anticipated to have concealed carry classes and that no shotguns or high powered firearms will be used. Only handguns will be used. Mr. Gryder stated that he has received questions from the public about some concerns and asked if Mr. Delaney has spoken to any of the neighbors about the proposed use. Mr. Delaney stated he has spoken to a few. Mr. Delaney stated that there will be fencing along the access the road on the subject property and fencing will be around the parking area and check in area. Mr. Gryder asked if the easement language addresses commercial uses. Attorney Kramer stated there are no specifics on the type of traffic on the easement. Mr. Delaney stated that as the volume of traffic increases on the access road he would be willing to upgrade it to tar and chip. David Guritz asked about wetlands on the property. Mr. Sterrett stated that there is a wetland at the northwest portion of the subject property but away from the shooting range. The Endangered Species Consultation report from IDNR did not identify any endangered or threatened species in the vicinity. Mr. Holdiman stated a condition should be placed on either the building permit or the special use that would provide a time limit for the use of the portable toilets and that plumbing will need to be addressed when the future building is constructed.

David Reinick described the operation of the range. New patrons to the range will be required to watch an 8-12 minute video about range safety and directions and then be required to view the video on an annual basis. A log will be kept of all those who have viewed the video to verify the last time that the video was watched. Each patron will be required to sign in when using the range. There will be range safety commands and signs posted throughout the range. Each range bay of 12 lanes will have one range safety officer to monitor. There will also be a certified chief range safety officer to oversee all the range bays as well as a daily inspection of the range. There will always be at least one employee per shooting bay hat is open and one individual in the building at all times.

Without futher questions or comments from the ZPAC committee, Mr. Sterrett stated the petition is schedule to go to the July 27<sup>th</sup> Plan Commission. Mr. Gryder made a motion, seconded by Mr. Klaas, to forward the petition onto the Plan Commission with a favorable recommendation. With a voice vote of all ayes, the motion carried.

# CIVIL PLANS FOR DIRT ROAD RANGE MINOOKA, IL.

## PLAN SHEET INDEX

- C-1 TITLE SHEET
- C-2 SITE PLAN
- C-3 GRADING PLAN

## ZONING INFO

THE SUBJECT PARCELS ARE DETERMINED TO BE CURRENTLY ZONED AS:  
A-1 AGRICULTURE

## PROPERTY INFO

P.I.N. : 08-25-300-006 ( 2.84 AC.)  
08-25-300-009 ( 30.66 AC.)

COMMONLY KNOWN AS:  
16502 CHURCH ROAD  
MINOOKA, IL 60447

## FLOOD ZONE INFO

THE SUBJECT PARCELS ARE DETERMINED TO BE OUTSIDE THE LIMITS OF THE 100-YEAR FLOODPLAIN PER KENDALL COUNTY FLOOD INSURANCE MAP NO. 17093C0200 G, PANEL 200 OF 225, EFFECTIVE FEBRUARY 4, 2009.

## BENCHMARKS

ELEVATION = 694.05

**SITE BENCHMARK :**  
MASONRY CUT NAIL IN THE SOUTH FACE OF POWER POLE AT NORTHWEST CORNER OF THE PROJECT SITE AT THE INTERSECTION OF PRIVATE ROAD AND THE WEST DRIVEWAY ENTRANCE.  
ELEVATION = 693.42

## GENERAL NOTES

1. REFERENCED PLAT OF SURVEY BY MORRISON SURVEYING COMPANY, INC. DATED 10/26/14
2. TOPOGRAPHIC SURVEY PERFORMED BY JCK ENGINEERS & BUILDERS, INC. 5/11/16
1. EROSION CONTROL TO BE APPLIED PER THE ILLINOIS URBAN MANUAL, LATEST EDITION.

## J.U.L.I.E. INFORMATION

NOTIFY J.U.L.I.E 2 WORKING DAYS PRIOR TO EXCAVATION  
1-800-892-0123

COUNTY: KENDALL  
MUNICIPALITY: MINOOKA, IL. 60447  
LOCATION: N.E. 1/4 OF S.W. 1/4 SECTION 25, T. 35N. R.7E.  
TOWNSHIP: LISBON  
ADDRESS: 16502 CHURCH ROAD

JAMIE L. BRADLEY  
ILLINOIS LICENSE # 062-049261  
EXPIRES 11/30/17

NO.	REVISIONS	DATE	BY
1	PER COUNTY REVIEW	7/19/16	JLB

TITLE PAGE

MINOOKA, ILLINOIS  
106 FORD DRIVE  
Storage Building & Site Improvements

DIRT ROAD  
RANGE

JCK  
ENGINEERS & BUILDERS, INC.  
450 WEST FIRST STREET  
BRAIDWOOD, IL. 60408  
(815) 458-0684  
jckengbltrs@yahoo.com

DATE:	5-9-16
SCALE:	AS SHOWN
DRAWN:	JLB
CHECK:	CK
JOB:	16-003
SHEET	C-1

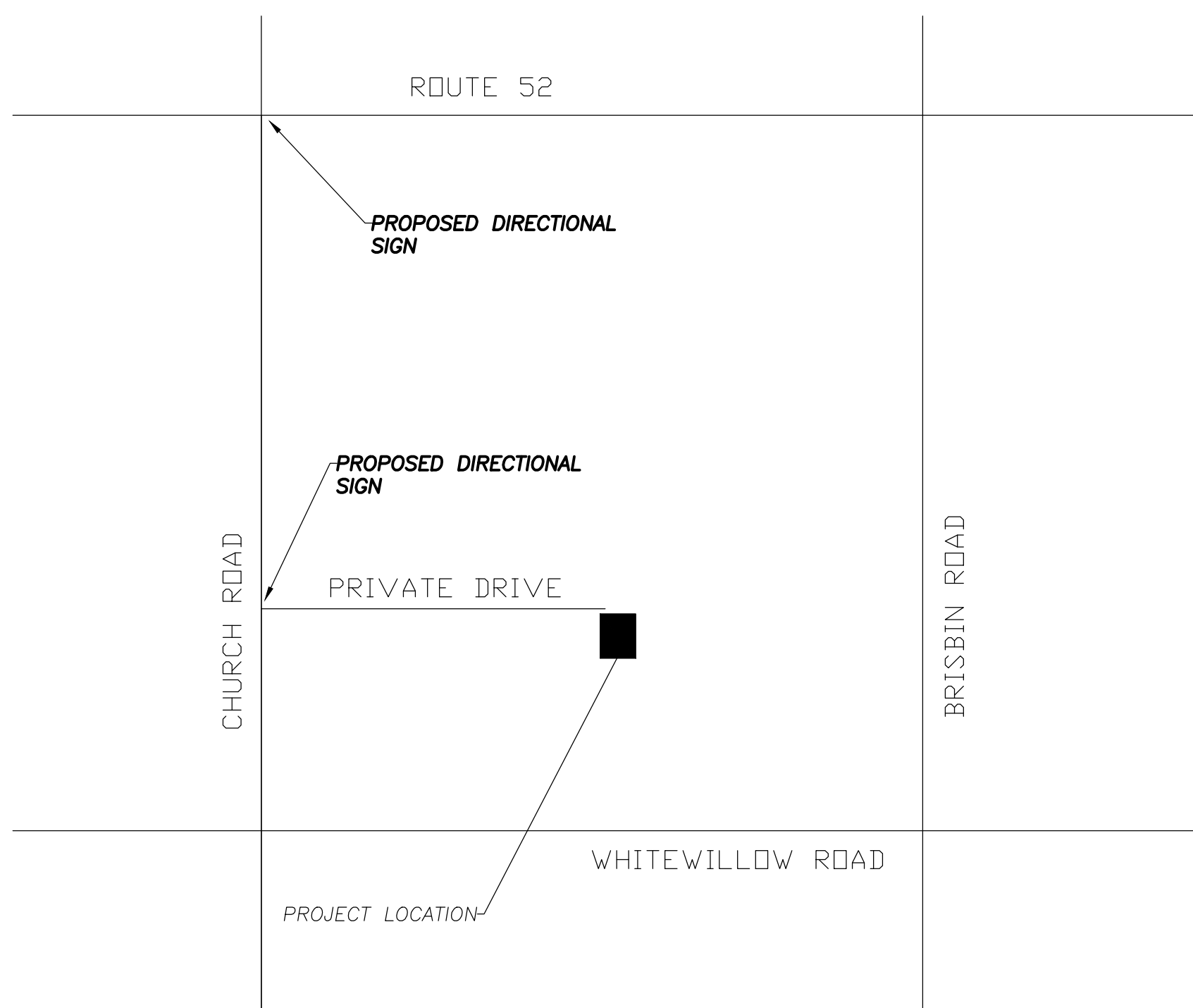

### LOCATION PLAN

NO SCALE

## LEGAL DESCRIPTION

PARCEL 2  
THE NORTHEAST QUARTER OF THE SOUTHWEST QUARTER OF SAIS SECTION 25, TOWNSHIP 35 NORTH, RANGE 7 EAST OF THE THIRD PRINCIPLE MERIDIAN, KENDALL COUNTY, ILLINOIS, AND ALSO A STRIP OF LAND 2 RODS WIDE OFF THE SOUTH SIDE OF THE SOUTH HALF OF THE NORTHWEST QUARTER OF SECTION 25, TOWNSHIP 35, RANGE 7 EAST OF THE THIRD PRINCIPLE MERIDIAN AND EXCEPTING THEREFROM BEGINNING AT THE NORTHWEST CORNER OF THE SOUTHWEST QUARTER SECTION 25; THENCE NORTH 89 DEGREES 59 MINUTES 55 SECONDS EAST ALONG THE NORTH LINE OF SAID SOUTHWEST QUARTER, 1333.03 FEET TO THE NORTHWEST CORNER OF THE NORTHWEST QUARTER OF SAID SOUTHWEST QUARTER; THENCE SOUTH 00 DEGREES 43 MINUTES 25 SECONDS WEST ALONG THE WEST LINE OF SAID NORTHEAST QUARTER, 703.38 FEET; THENCE NORTH 89 DEGREES 59 MINUTES 55 SECONDS EAST 295.18 FEET; THENCE NORTH 00 DEGREES 43 MINUTES 25 SECONDS EAST, 736.39 FEET TO THE NORTH LINE OF THE SOUTH 2 RODS OF THE SOUTH HALF OF SAID NORTHWEST QUARTER; THENCE SOUTH 00 DEGREES 41 MINUTES 00 SECONDS WEST 3300 FEET TO THE POINT OF BEGINNING, FURTHER EXCEPTING THEREFROM.  
THAT PART OF THE NORTHEAST QUARTER OF THE SOUTHWEST QUARTER OF SECTION 25 AND PART OF THE NORTHWEST QUARTER OF THE SECTION 25, ALL IN THE TOWNSHIP 35 NORTH, RANGE 7 EAST OF THE THIRD PRINCIPLE MERIDIAN, DESCRIBED AS FOLLOWS: COMMENCING AT THE NORTHWEST CORNER OF THE SOUTHWEST QUARTER OF SECTION 25; THENCE NORTH 89 DEGREES 59 MINUTES 55 SECONDS EAST ALONG THE NORTH LINE OF SAID SOUTHWEST QUARTER, 1333.03 FEET TO THE NORTHWEST CORNER OF THE NORTHEAST QUARTER OF THE SOUTHWEST QUARTER OF SAID SECTION 25; THENCE SOUTH 00 DEGREES 43 MINUTES 25 SECONDS WEST ALONG THE WEST LINE OF THE NORTHEAST QUARTER OF THE SOUTHWEST QUARTER OF SAID SECTION 25, FOR A DISTANCE OF 295.18 FEET TO THE POINT OF BEGINNING; THENCE NORTH 00 DEGREES 43 MINUTES 25 SECONDS EAST, 328.18 FEET TO THE NORTH LINE OF THE SOUTH 2 RODS OF THE SOUTH HALF OF THE NORTHWEST QUARTER OF SAID SECTION 25; THENCE NORTH 89 DEGREES 59 MINUTES 55 SECONDS EAST ALONG NORTH LINE OF THE SOUTH 2 RODS OF THE SOUTH HALF OF THE NORTHWEST QUARTER OF SAID SECTION 25, 132.74 FEET TO THE POINT OF BEGINNING; ALL IN KENDALL COUNTY, ILLINOIS.

PARCEL 3  
THAT PART OF THE NORTHWEST QUARTER OF THE SOUTHWEST QUARTER OF SECTION 25, TOWNSHIP 35 NORTH, RANGE 7, EAST OF THE THIRD PRINCIPLE MERIDIAN, DESCRIBED AS FOLLOWS: COMMENCING AT THE NORTHWEST CORNER OF THE SOUTHWEST QUARTER OF SAID SECTION 25; THENCE NORTH 89 DEGREES 59 MINUTES 55 SECONDS EAST ALONG THE NORTH LINE OF SAID SOUTHWEST QUARTER, 1333.03 FEET TO THE NORTHWEST CORNER OF THE NORTHEAST QUARTER OF THE SOUTHWEST QUARTER OF SAID SECTION 25; THENCE SOUTH 00 DEGREES 34 MINUTES 25 SECONDS WEST ALONG THE WEST LINE OF THE NORTHEAST QUARTER OF THE SOUTHWEST QUARTER OF SAID SECTION 25, FOR A DISTANCE OF 295.18 FEET TO THE BEGINNING; THENCE NORTH 89 DEGREES 59 MINUTES 55 SECONDS WEST 295.18 FEET; THENCE SOUTH 00 DEGREES 43 MINUTES 25 SECONDS WEST, 408.20 FEET; THENCE SOUTH 89 DEGREES 59 MINUTES 55 SECONDS WEST, 295.18 FEET TO THE WEST LINE OF THE NORTHEAST QUARTER OF THE SOUTHWEST QUARTER OF SAID SECTION 25; THENCE NORTH 00 DEGREES 43 MINUTES 25 SECONDS EAST ALONG THE WEST LINE OF THE NORTHEAST QUARTER OF THE SOUTHWEST QUARTER OF SAID SECTION 25, FOR A DISTANCE OF 408.20 FEET TO THE POINT OF BEGINNING, IN KENDALL COUNTY, ILLINOIS.

PARCEL 4  
AN EASEMENT FOR INGRESS AND EGRESS ACROSS THE FOLLOWING DESCRIBED REAL ESTATE; THE SOUTH 33 FEET OF THE NORTHWEST QUARTER OF SECTION TOWNSHIP 35 NORTH, RANGE 7 EAST OF THE THIRD PRINCIPLE MERIDIAN, KENDALL COUNTY, ILLINOIS.

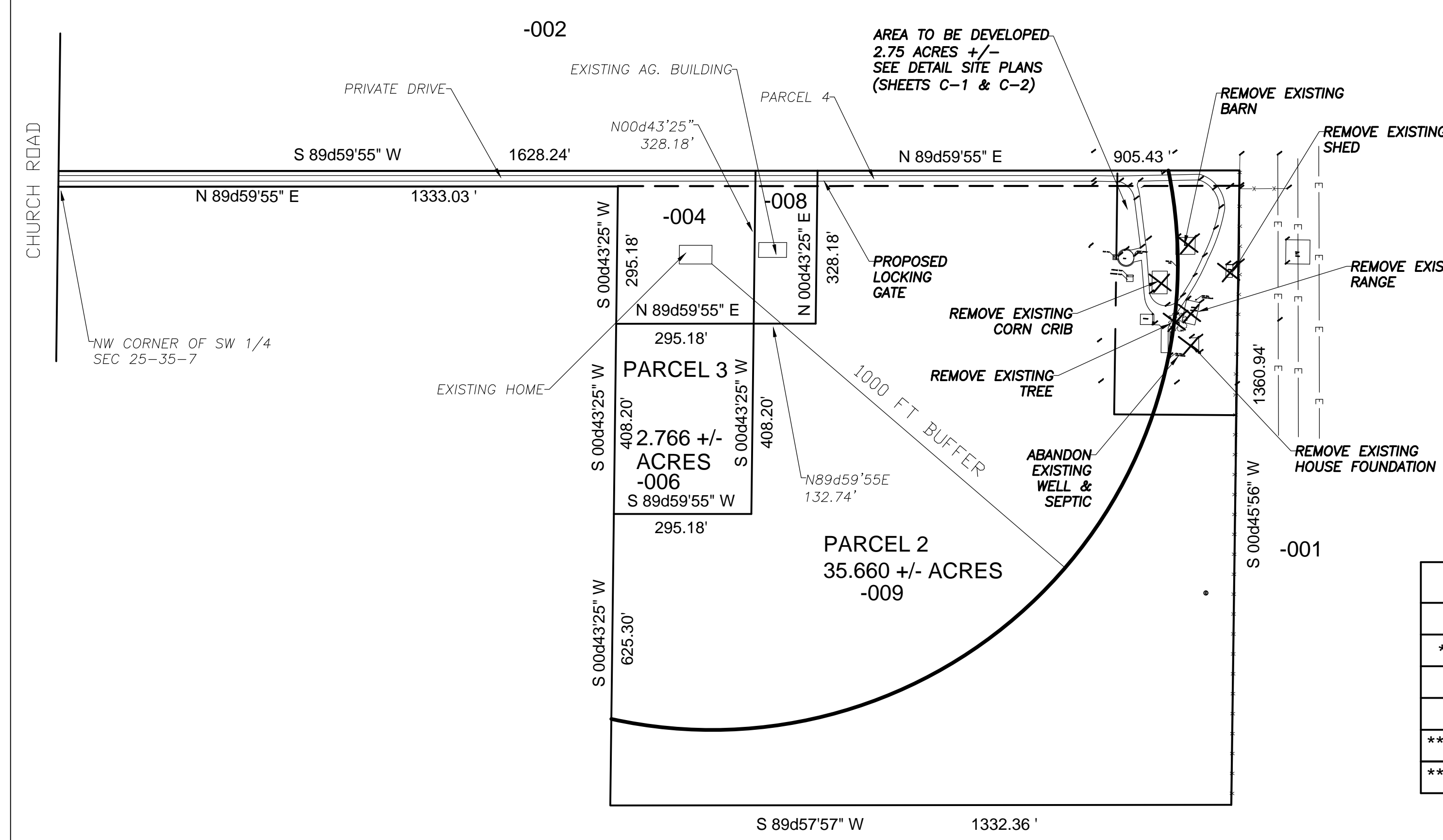

### OVERALL SITE PLAN

1"=200'

## SITE TABLE (DEVELOPED AREA)

DESCRIPTION	EXISTING	PROPOSED
BUILDINGS	6,967	1,602
* PARKING LOT	21,086	36,974
LOT SIZE	119,570	119,570
BUILDING COVERAGE (%)	5.83%	1.34%
** IMPERVIOUS COVERAGE (%)	23.46%	29.75%
** IMPERVIOUS COVERAGE	28,035	38,576

MAXIMUM BUILDING COVERAGE = 60%  
INCREASE IN IMPERVIOUS COVERAGE = 10,541 SF  
\* INCLUDES GRAVEL AND CONCRETE SLAB AREAS  
\*\* INCLUDES BUILDINGS, GRAVEL AND CONCRETE SLAB AREAS

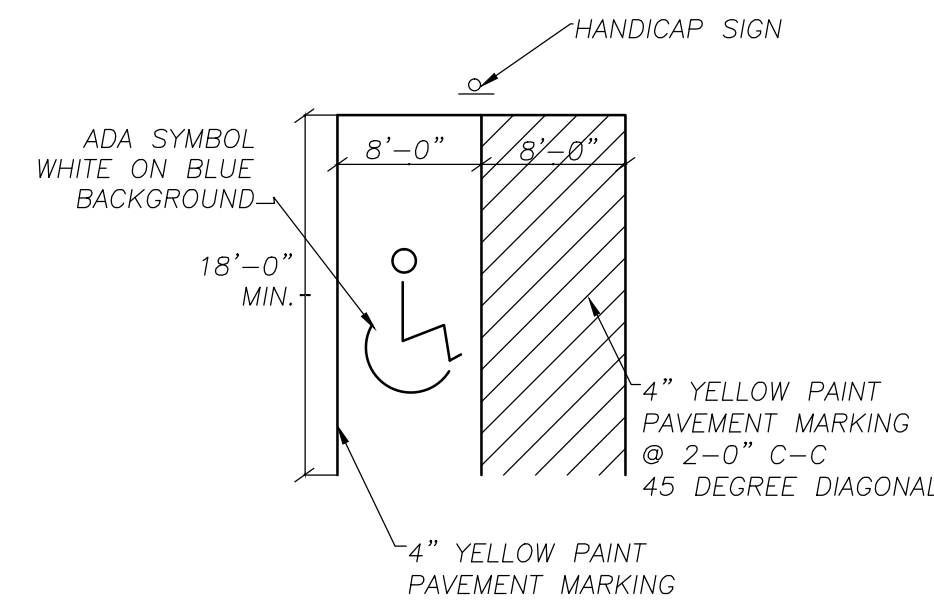
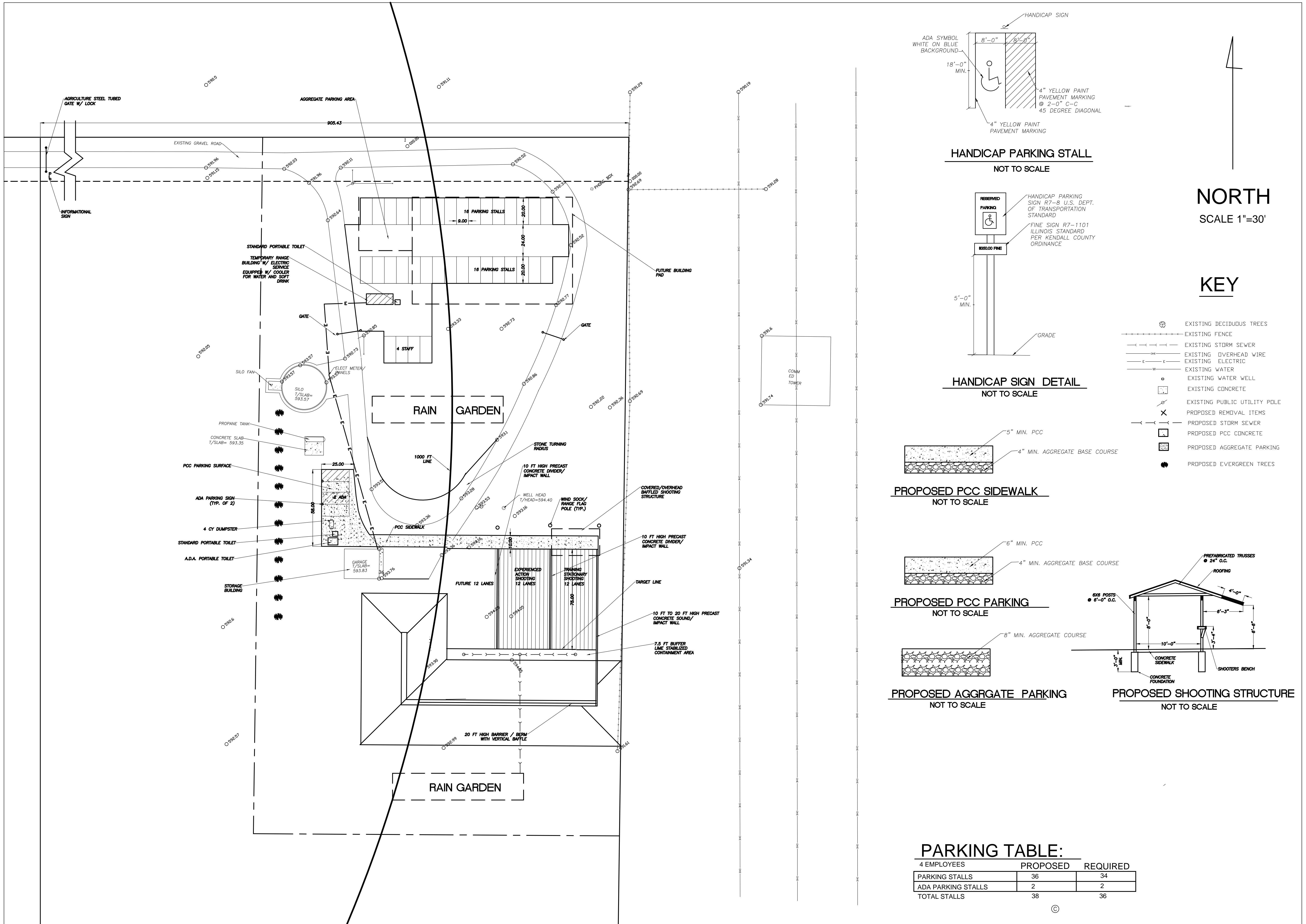

**HANDICAP PARKING STALL**  
NOT TO SCALE

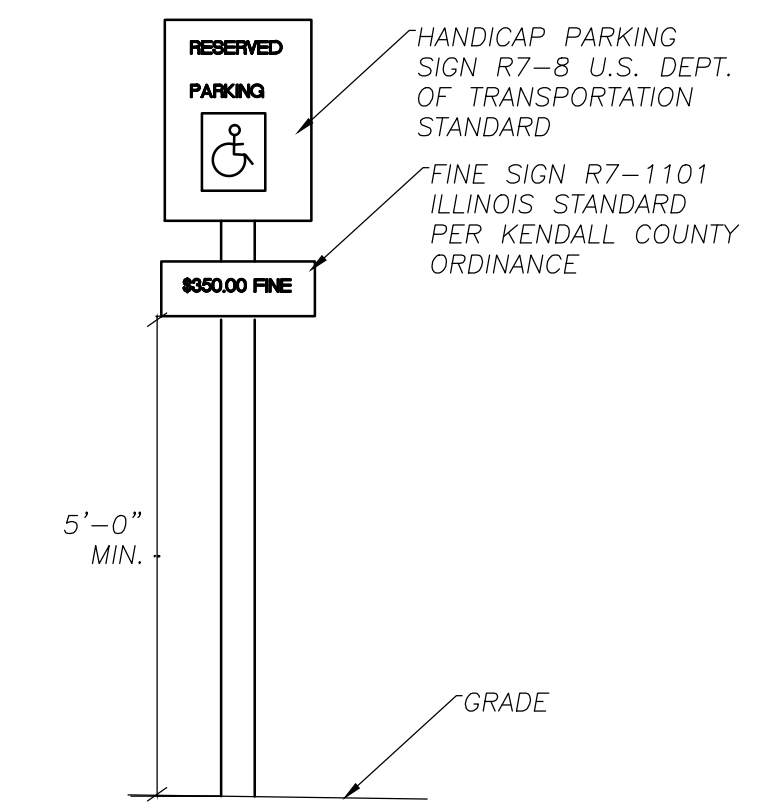

**HANDICAP SIGN DETAIL**  
NOT TO SCALE

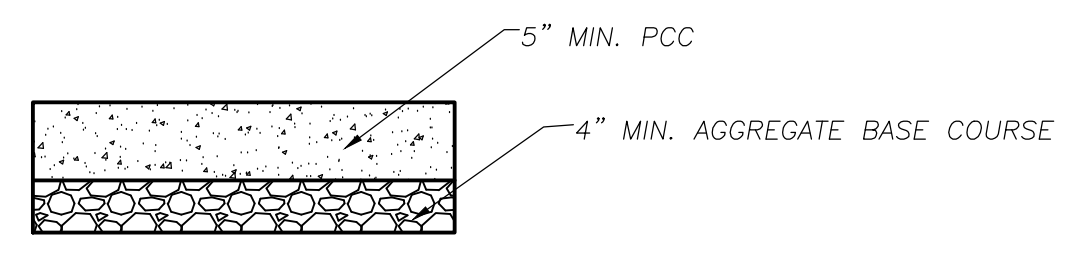

**PROPOSED PCC SIDEWALK**  
NOT TO SCALE

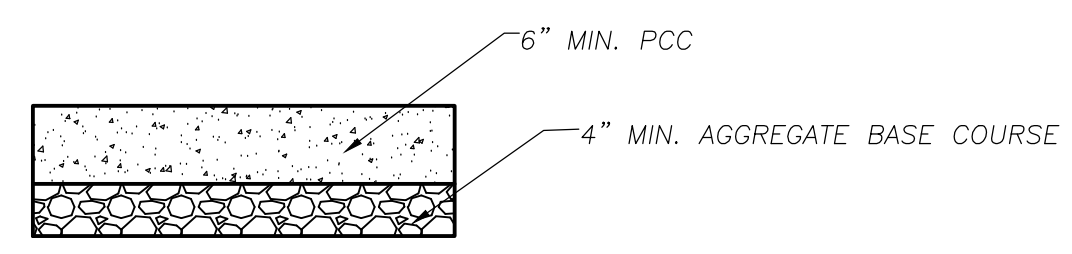

**PROPOSED PCC PARKING**  
NOT TO SCALE

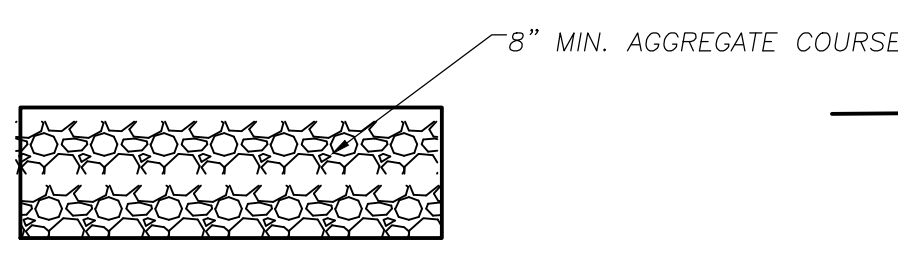

**PROPOSED AGGREGATE PARKING**  
NOT TO SCALE

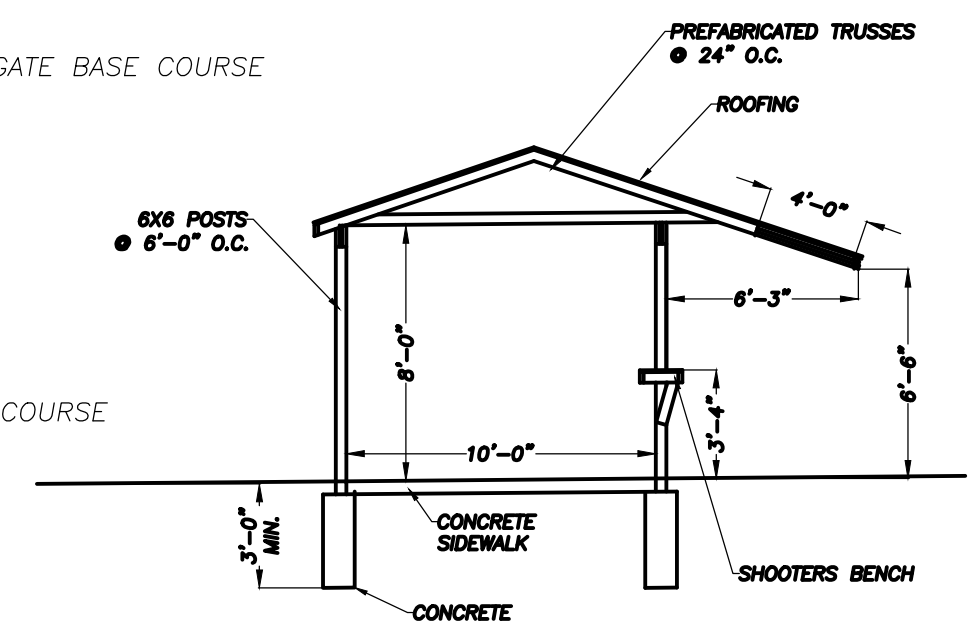

**PROPOSED SHOOTING STRUCTURE**  
NOT TO SCALE

**NORTH**  
SCALE 1"=30'

**KEY**

- EXISTING DECIDUOUS TREES
- EXISTING FENCE
- EXISTING STORM SEWER
- EXISTING OVERHEAD WIRE
- EXISTING ELECTRIC
- EXISTING WATER
- EXISTING WATER WELL
- EXISTING CONCRETE
- EXISTING PUBLIC UTILITY POLE
- ✕ PROPOSED REMOVAL ITEMS
- PROPOSED STORM SEWER
- PROPOSED PCC CONCRETE
- PROPOSED AGGREGATE PARKING
- PROPOSED EVERGREEN TREES

**PARKING TABLE:**

	PROPOSED	REQUIRED
4 EMPLOYEES		
PARKING STALLS	36	34
ADA PARKING STALLS	2	2
TOTAL STALLS	38	36

NO.	REVISIONS	DATE	BY
1	PER COUNTY REVIEW	7/20/16	JLB

**SITE PLAN**

**MINOOKA, ILLINOIS**  
CHURCH ROAD  
Site Improvements

**DIRT ROAD RANGE**

**JCK**  
ENGINEERS & BUILDERS, INC.  
450 WEST FIRST STREET  
BRADWOOD, IL 60408  
(615) 458-0684  
jckengbldrs@yahoo.com

DATE:	5-9-16
SCALE:	AS SHOWN
DRAWN:	JLB
CHECK:	CK
JOB:	16-003

**C-2**

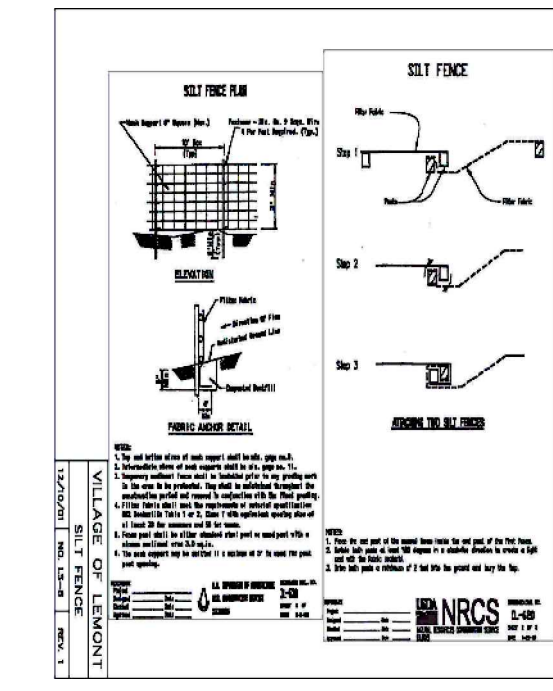
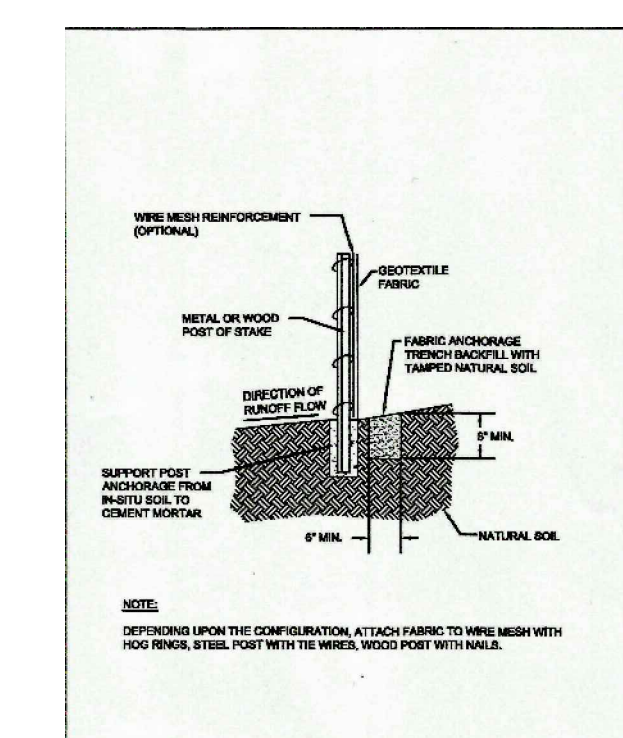
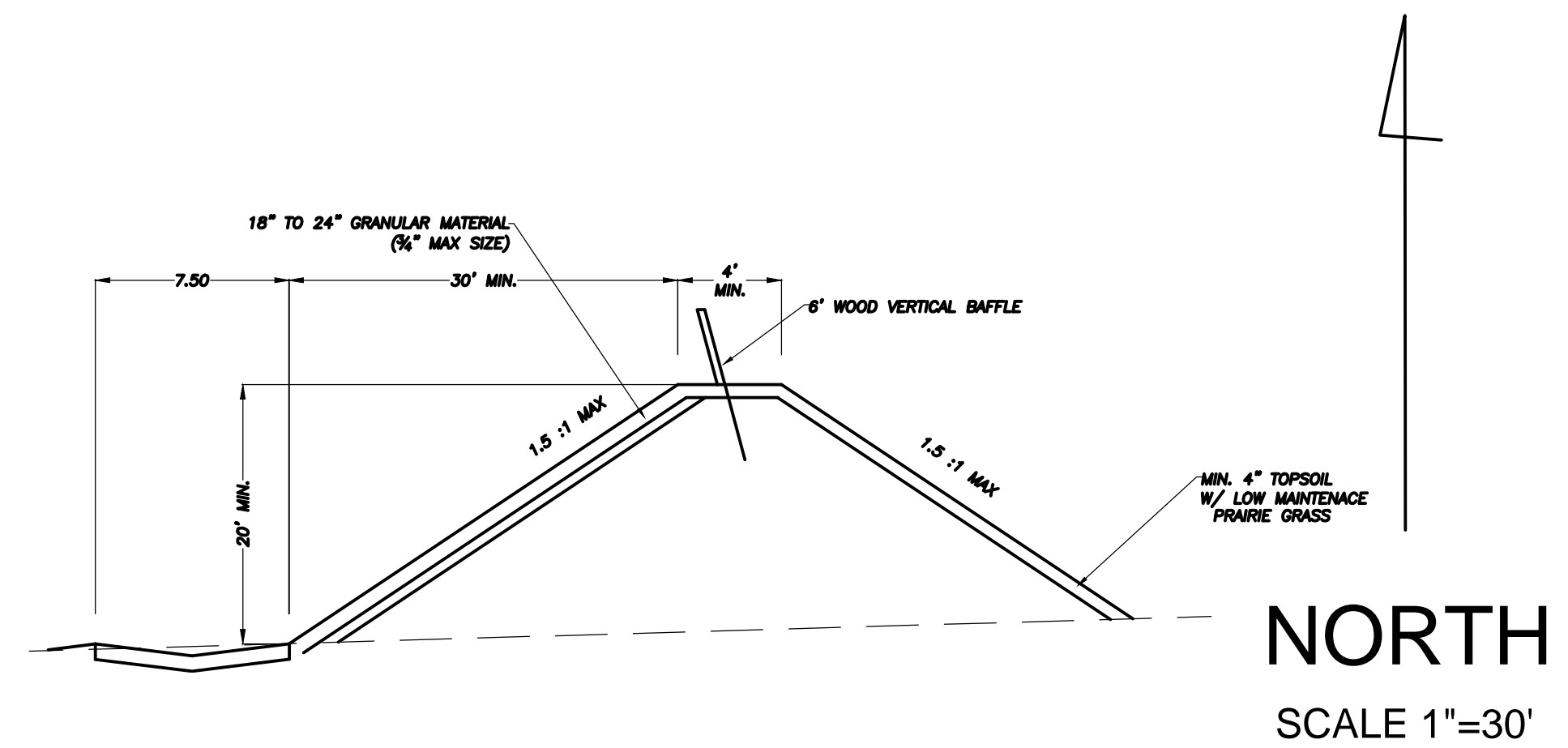
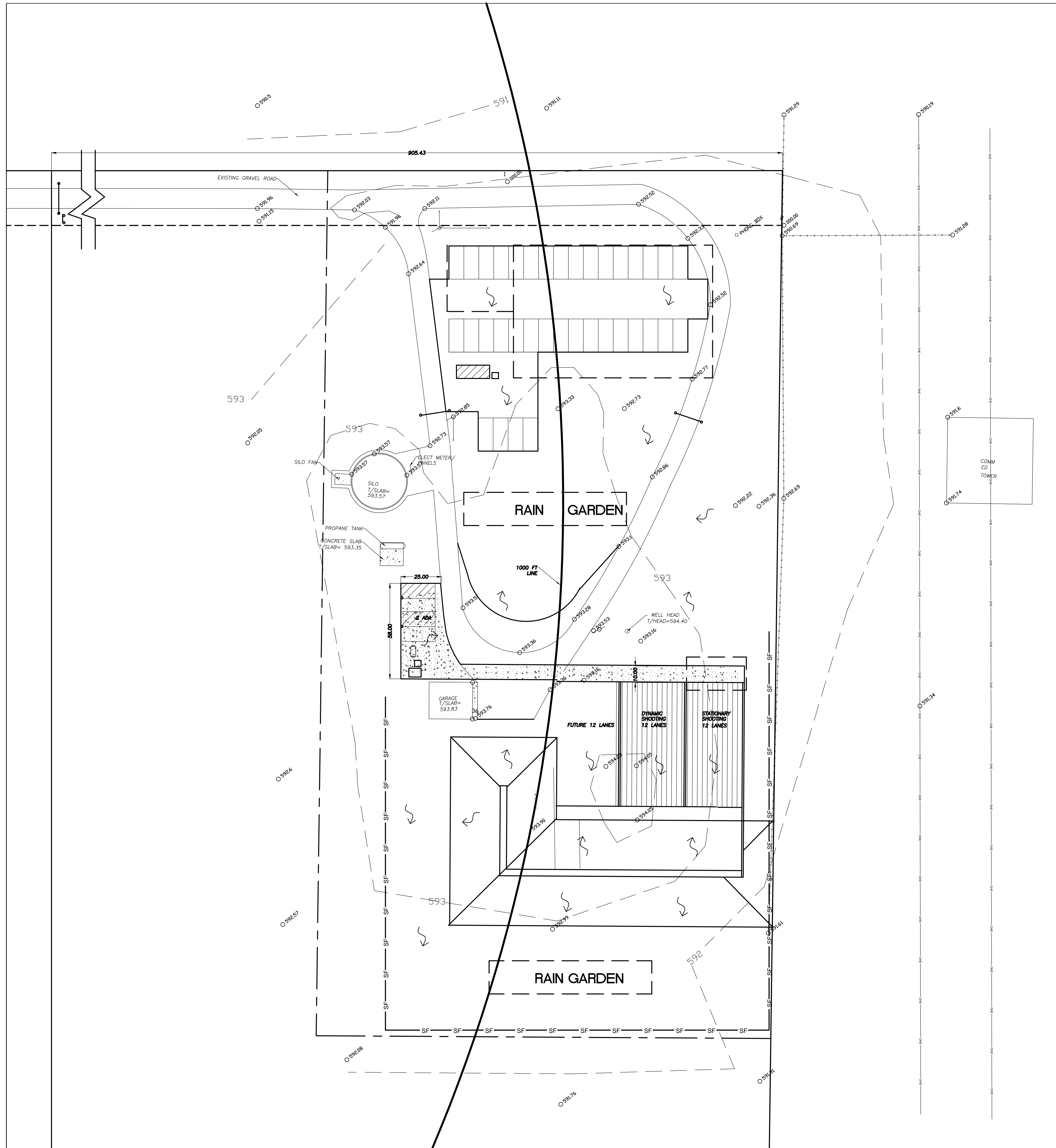

**NORTH**  
SCALE 1"=30'

**KEY**

- EXISTING FENCE
- EXISTING STORM SEWER
- EXISTING OVERHEAD WIRE
- EXISTING ELECTRIC
- EXISTING WATER
- EXISTING WATER WELL
- EXISTING CONCRETE
- EXISTING PUBLIC UTILITY POLE
- EXISTING PUBLIC UTILITY POLE
- 593 --- EXISTING CONTOUR
- PROPOSED REMOVAL ITEMS
- PROPOSED STORM SEWER
- SF --- PROPOSED SILT FENCE
- PROPOSED INLET FILTER
- PROPOSED FLOW ARROW
- PROPOSED PCC CONCRETE
- PROPOSED GRADE
- 593 --- PROPOSED CONTOUR
- PROPOSED PCC CONCRETE

NO.	REVISIONS	DATE	BY
1	PER COUNTY REVIEW	7/18/16	JLB

**GRADING PLAN**

**MINOOKA, ILLINOIS**  
CHURCH ROAD  
Site Improvements

**DIRT ROAD RANGE**

**JCK**  
ENGINEERS & BUILDERS, INC.  
450 WEST FIRST STREET  
BRADWOOD, IL 60408  
(815) 458-0684  
jckengbltrs@yahoo.com

DATE:	5-9-16
SCALE:	AS SHOWN
DRAWN:	JLB
CHECK:	CK
JOB:	16-003

**C-3**



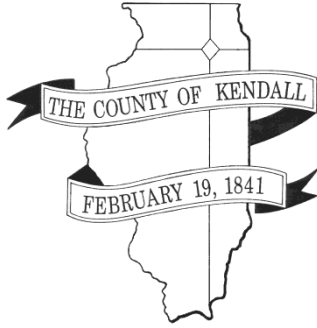

---

---

**DEPARTMENT OF PLANNING, BUILDING & ZONING**

111 West Fox Street • Room 203

Yorkville, IL • 60560

(630) 553-4141

Fax (630) 553-4179

---

---

**Petition 16-16**

**Megan and Chris Jensen**

**A-1 Special Use – Landscape/Excavating Operation**

**SITE INFORMATION**

PETITIONER Megan and Chris Jensen

ADDRESS 7225 Caton Farm Road

LOCATION North side of Caton Farm Road; 0.20 mi west of Church Road



TOWNSHIP Kendall

PARCEL # 05-26-400-004; Pt 05-26-400-005

LOT SIZE 7.58 acres

EXITING LAND Residential/Agricultural  
USE

ZONING A-1 Agricultural District

LRMP	Land Use	Rural Estate Residential (Max Density=0.45 DU/AC)
	Roads	Caton Farm Road is a County road classified as a Major Collector Road
	Trails	None
	Floodplain/Wetlands	No floodplain or wetlands exist on the property

**REQUESTED ACTION  
APPLICABLE REGULATIONS**

A-1 Special Use to operate a landscaping and excavating business

Section 7.01 D.28 – A-1 Special Uses – Permits Landscape Businesses with the following stipulations:

1. All vehicles, equipment and materials associated with a landscaping business shall be stored entirely within an enclosed structure, unless otherwise permitted under the terms of this Special Use Permit.
2. The business shall be located on, and have direct access to, a State, County or Collector Highway as identified in the County's LRMP, having an all-weather surface, designed to accommodate loads of at least 73,280 lbs, unless otherwise approved in writing by the agency having jurisdiction over said Highway. Such approvals shall establish limitations as to the number of employees and types of vehicles coming to and from the site that are engaged in the operation of the use (including delivery vehicles). These restrictions shall be included as controlling conditions of the Special Use. (Amended 7/17/2007)
3. No landscape waste generated off the property can be burned on this site

Section 13.08 – Special Use Procedures

An excavating operation is not permitted in the A-1 Agricultural as a special use

**SURROUNDING LAND USE**

Location	Adjacent Land Use	Adjacent Zoning	Land Resource Management Plan	Zoning within ½ Mile
North	Agricultural	A-1	Rural Estate Res.	A-1
South	Agricultural/Residential	A-1	Rural Estate Res.	A-1
East	Agricultural	A-1	Rural Estate Res.	A-1; A-1 SU
West	Agricultural/Residential	A-1	Rural Estate Res.	A-1; A-1 SU



**PHYSICAL DATA**

**ENDANGERED SPECIES REPORT**

A corrected EcoCAT report must be submitted

**NATURAL RESOURCES INVENTORY**

The Kendall County Soil & Water Conservation District is preparing an NRI Executive Report to be submitted to the Planning, Building, and Zoning Department.

**ACTION SUMMARY**

**KENDALL TOWNSHIP**

Petition information was sent to Kendall Township 6.24.16. No comments have been received from Kendall Township.

**ZPAC (7.12.16)**

The petitioners were informed that if the proposed 16,000sf building is to be used for vehicle maintenance including oil changes then a triple basin interceptor must be installed as well as a class V injection well. A building permit is required for this building. A stormwater management permit will also be required.

The ZPAC forwarded the petition onto the July 27<sup>th</sup> Plan Commission meeting with a favorable recommendation.

**GENERAL**

Chris and Megan Jensen are requesting an A-1 Special Use to operate a landscaping and excavating business at the subject property. A landscape operation is permitted as a special use on an A-1 property with certain conditions. Those conditions include:

1. All vehicles, equipment and materials associated with a landscaping business shall be stored entirely within an enclosed structure, unless otherwise permitted under the terms of this Special Use Permit.
2. The business shall be located on, and have direct access to, a State, County or Collector Highway as identified in the County's LRMP, having an all-weather surface, designed to accommodate loads of at least 73,280lbs, unless otherwise approved in writing by the agency having jurisdiction over said Highway. Such approvals shall establish limitations as to the number of employees and types of

vehicles coming to and from the site that are engaged in the operation of the use (including delivery vehicles). These restrictions shall be included as controlling conditions of the Special Use. (Amended 7/17/2007)

3. No landscape waste generated off the property can be burned on this site

An excavation operation is not permitted as a special use in the A-1 Agricultural District.

### **BUSINESS OPERATION**

The operation will include landscape maintenance, installation of landscaping, and related activities. No yard waste will be stored on-site with the possible exception of balled trees and bushes that have been prepared for installation. No retail or wholesale material will occur on site. No outdoor storage will take place and all equipment will be kept within a proposed building. No landscape waste will be stored on-site. The petitioner has indicated that no more than three (3) employees will be part of the operation with none of them reporting to the subject property. All employees report directly to the job site. The petitioners will reside on the property.

The petitioner has indicated that much of the equipment used in the landscaping business is related to excavating including diggers, small and large, and dump trucks used to haul dirt for installation of plant material.

### **BUILDING CODES**

A 16,000sf building is proposed on the north end of the property to be used for storage of all equipment. This building will require a building permit.

### **ACCESS**

The property has an existing access point onto Caton Farm with an asphalt drive. The submitted site plan proposes a widening of this drive on the subject property as well as within the R.O.W. of Caton Farm Road.

### **PARKING**

No parking is identified on the site plan. A proposed gravel area is located to the north of the site surrounding a proposed 16,000sf building. The petitioners have indicated that there will be no more than three (3) employees reporting to the site and that no wholesale or retail will be offered to the public. Staff is of the opinion that this gravel parking area will be adequate for employee parking. This gravel area and the proposed pond near it may require a stormwater management permit.

### **LIGHTING**

No lighting is proposed with the exception of a security light at the south edge of the proposed building.

### **SIGNAGE**

A proposed non-lit free-standing sign is depicted at the southwest corner of the property along Caton Farm Road. This sign is subject to the requirements of Section 12 of the Zoning Ordinance and must be setback at least ten (10) feet from the edge of the ROW.

### **SCREENING**

The Zoning Ordinance requires all vehicles, equipment and materials associated with a landscaping business shall be stored entirely within an enclosed structure, unless otherwise permitted under the terms of this Special Use Permit. The petitioner has indicated all equipment will be stored within the proposed building satisfying this requirement.

### **CONCLUSION**

The proposed use of the property for a landscaping operation is considered permitted as special use in the A-1 District with certain requirements. An excavating operation, however, is not considered permitted as a special use in the A-1 District.

### **RECOMMENDATION**

If approved, staff recommends the following conditions be included in the approving special use ordinance:

1. All vehicles, equipment and materials associated with a landscaping business shall be stored entirely within an enclosed structure, unless otherwise permitted under the terms of this Special Use Permit
2. No employees are permitted to report to the site

3. No landscape waste generated off the subject property may be burned on the subject property
4. A building permit shall be applied for and approved prior to the construction of the proposed building
5. All required site development permits shall be applied for and approved prior to start of construction
6. Proposed signage shall require a building permit and be subject to the sign requirements of Section 12 of the Zoning Ordinance.
7. The granting of this special use is only for a landscape operation and for those activities typically associated with a landscaping operation. Any other uses on the property not considered to be permitted by right or by special use are prohibited.

**ATTACHMENTS**

1. Zoning Plat
2. Letter to PBZ 7.7.16
3. ZPAC Minutes 7.12.16

# ZONING PLAT OF PART OF THE SOUTHEAST QUARTER OF SECTION 26, T36N-R7E, 3rd P.M. KENDALL TOWNSHIP      KENDALL COUNTY      ILLINOIS

## LEGAL DESCRIPTION OF TRACT TO BE REZONED:

### LEGAL DESCRIPTION OF PARCEL ONE:

The South 660.00 feet of the West 330.00 feet of the East Half of the Southeast Quarter of Section 26, Township 36 North, Range 7 East of the Third Principal Meridian, in the Township of Kendall Kendall County, Illinois, (EXCEPTING therefrom that part described as follows: Commencing at the Southwest Corner of the East Half of said Southeast Quarter; thence Easterly along the South Line of said Southeast Quarter, 215.0 feet for a point of beginning; thence continuing Easterly along said South Line, 115.0 feet to the East Line of the West 330.00 feet of the East Half of said Southeast Quarter; thence Northerly along said East Line, 393.39 feet; thence Southwesterly, 274.98 feet to a point that is 144.55 feet North of the point of beginning on a Line drawn parallel with the East Line of the West 330.00 feet of said Southeast Quarter; thence Southerly along said parallel line, 144.55 feet to the point of beginning).

### LEGAL DESCRIPTION OF PARCEL TWO:

The South 1056.01 feet (EXCEPTING therefrom the South 660.00 feet) of the West 330.00 feet of the East Half of the Southeast Quarter of Section 26, Township 36 North, Range 7 East of the Third Principal Meridian, in the Township of Kendall Kendall County, Illinois.

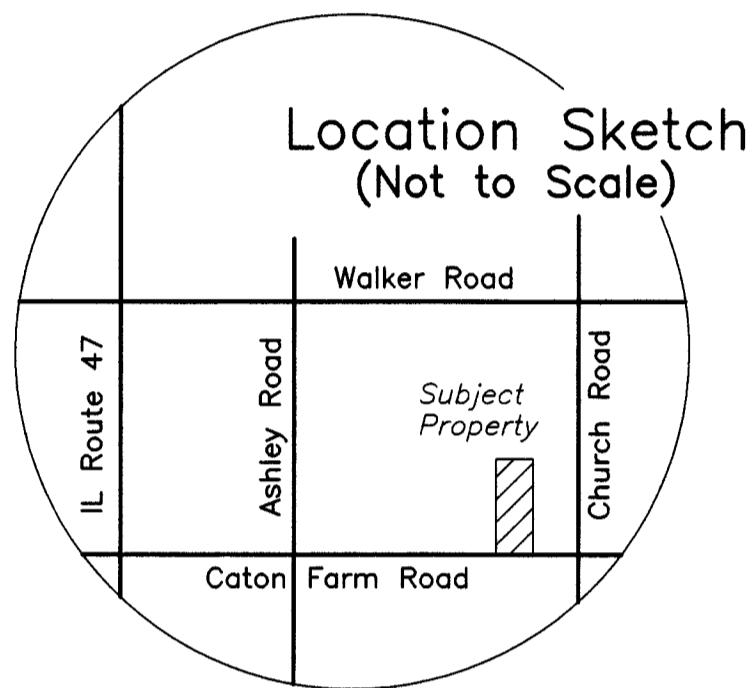

### SOILS (From USCS Soils Map)

- 145B** Saybrook Silt Loam, 2 to 5% slopes
- 145C2** Saybrook Silt Loam, 5 to 10% slopes, eroded
- 152A** Drummer Silty Clay Loam, 0 to 2% slopes

### AREA TO BE REZONED:

7.2898 Acres  
(7.0430 Acres Excluding Roads)

### PRESENT ZONING:

A1

### PROPOSED ZONING:

A1-SU (Excavating Landscape)

### DEVELOPER:

Chris and Megan Jensen  
8751 East Highpoint Road, Suite C  
Yorkville, Illinois 60560

N

SCALE  
1"=40'

- Indicates Iron Stake Found
- Indicates Iron Stake Set
- Indicates Line of Fence
- 653— Indicates Contour Elevation

NOTE: This property is commonly known as 7225 Caton Farm Road.

P.I.N. 05-26-400-004  
05-26-400-005

### BENCHMARKS - (NGVD1929)

- BM#1 - Cross in Concrete Trim at Southeast Corner of Barn Elevation = 656.17
- BM#2 - Magnail in Asphalt Drive West of Brick and Frame Residence Elevation = 658.10
- BM#3 - Magnail in Pavement at Southwest Corner of Property Elevation = 651.47
- BM#4 - Magnail in Pavement at Southeast Corner of Property Elevation = 648.86

State of Illinois } SS  
County of Kendall }

I, Phillip D. Young, an Illinois Professional Land Surveyor and an officer of Phillip D. Young and Associates, Inc., state that I have surveyed and located the visible improvements upon the attached described tract as shown by the plat hereon drawn which is a representation of said survey. Field work completed May 12, 2016. This professional service conforms to the current Illinois minimum standard for a boundary survey.

Dated May 17, 2016 at Yorkville, Illinois

*Phillip D. Young*  
Phillip D. Young  
Illinois Professional Land Surveyor No. 2678 (Expires 11/30/16)

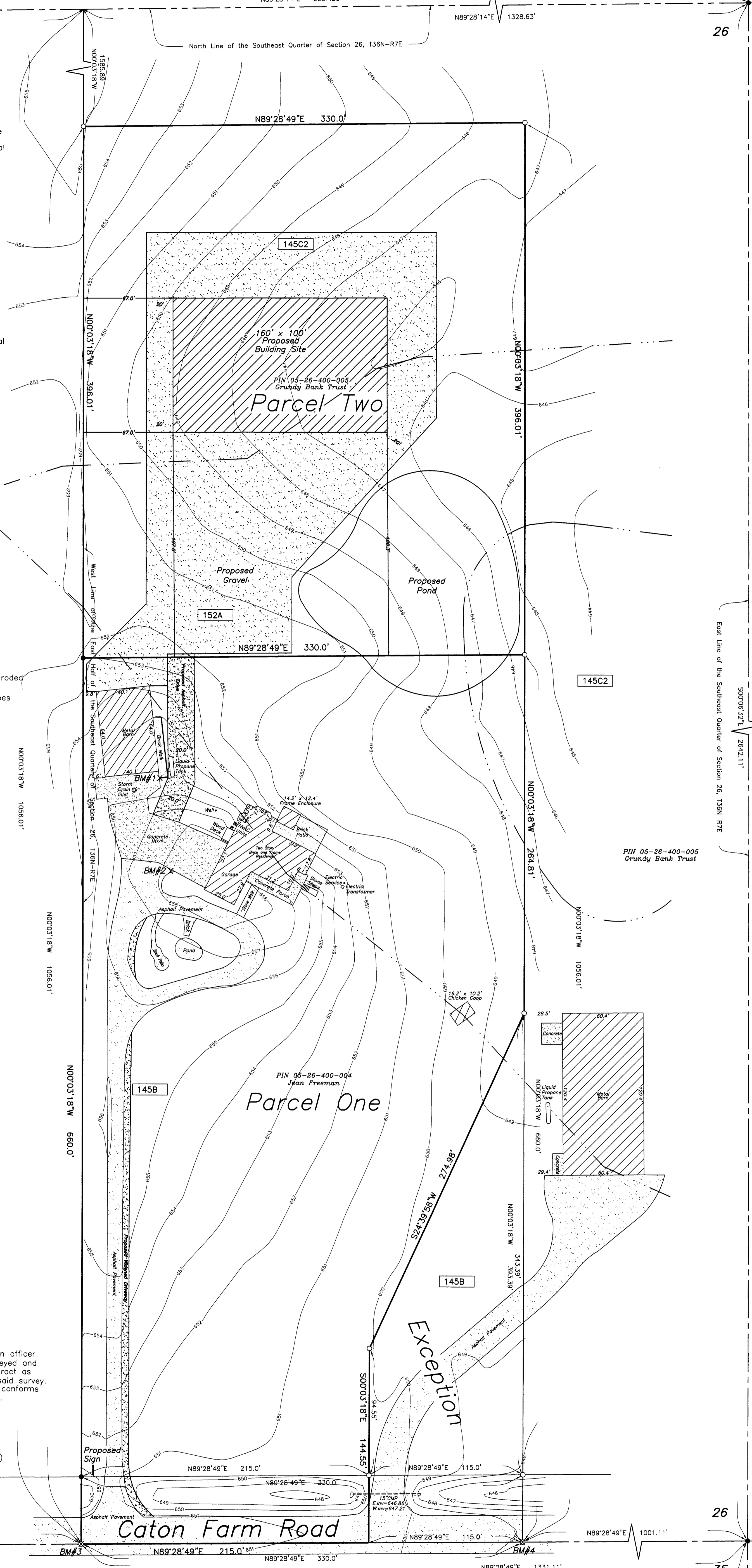

JOB NO.	16073
JOB NAME	JENSEN
DWG FILE	16073B
REVISION DATE	

**Phillip D. Young and Associates, Inc.**  
LAND SURVEYING - TOPOGRAPHIC MAPPING - Lic.#184-002775

1107B South Bridge Street  
Yorkville, Illinois 60560  
Telephone (630)553-1580

LAW OFFICES  
OF

***Daniel J. Kramer***

1107A SOUTH BRIDGE STREET  
YORKVILLE, ILLINOIS 60560  
(630) 553-9500  
Fax: (630) 553-5764

**DANIEL J. KRAMER**

**KELLY A. KRAMER  
D.J. KRAMER**

July 7, 2016

John Sterrett  
Kendall County PB & Z  
111 W. Fox Street  
Yorkville, IL 60560

RE: Chris Jensen Landscaping Special Use

Dear John:

In regard to the June 24, 2016 Letter you sent I can provide the following information:

Description of Proposed Use

1. Much of the equipment used in his landscaping business is in fact related to excavating. He has small diggers, larger digger, dump trucks and the like to haul dirt for installation of plant material and the like. That's why we included the description of the excavation so that people knew that in regard to landscaping there is some machinery involved. We feel that is related to the landscaping and nursery use in that he plans to also plant a substantial numbers of trees and berming on the subject property subject to getting a site development permit. Hopefully that provides an answer to this question.
2. In regard to the operation he does landscape maintenance, installation of landscaping, and related activities. No yard waste will be stored on-site just perhaps balled trees and bushes ready for installation further there will be no retail or wholesales of materials at the site.

The building he purposes to use will allow for the complete storage of all equipment indoor and he will not provide any outdoor storage for vehicles, equipment, and the like.

He stores no landscape waste on-site and doesn't in his current home business that he is the sole operator together with his wife.

They would not expect at any time to have more than 3 employees.

3. The workshop internal in the building would be for storage of equipment when not being used, office, and repair area within the building.
4. We believe we have both parcel 1 and parcel 2 as part of the zoning application if we don't please consider both parcels and pin numbers 05-26-400-004 and 05-26-400-005 as part of the Petition. The reason that parcel 1 needs to be included is the fact that it contains the driveway to the rear of parcel 2 which is where the actual Special Use will be located is both parcels one and two are going to be acquired from Mr. and Mrs. Jensen from Jean Freeman. While she holds Title to parcel 1 in her individual name she is also the sole beneficiary of the Grundy County Trust that owns parcel 2 and has consented to the Zoning Special Use Request. If you need a letter from her in addition to the Application she signed and I will be happy to provide it.
5. I believe we have answered above, there should not be a need for ADA accessibility parking although again on the gravel surface we can add a sign for in that because of the strenuous nature of the work it would be very difficult to have a handicapped employee.
6. The only lighting that would be proposed would be a security light at the south edge of the building being constructed. There would be no lit sign although we would propose a low level landscape sign immediately to the east of the driveway out of the right-of-way at Caton Farm Road as shown on the plan.
7. We believe we have provided the answer to storage within the enclosed structure.

Other

I don't know how IDNR EcoCat came up with the Fox Township location in that the parcel is clearly located in Kendall Township pretty much to the middle and has Kendall Township Pin Numbers we will contact IDNR and ask them to revisit and send a correct aerial.

Should you have any questions or concerns please feel free to contact me.

Very truly yours,

Daniel J. Kramer,  
Attorney at Law

DJK/cth



**#16-16 – Megan and Chris Jensen**

Mr. Sterrett outlined the request for a special use in the A-1 Agricultural District to operate a landscape and excavating business at 7225 Caton Farm Road in Kendall Township on the north side of Caton Farm Road, just west of Church Road. Mr. Sterrett pointed out that excavating businesses are not permitted in the A-1 Agricultural District either by right or by special use and therefore the special use request may only include a landscape operation. Staff recommends that an additional condition be added to the special use ordinance that permits only uses typically found in landscape businesses and that the approval is not for an excavating business.

The operation will include landscape maintenance, installation of landscaping, and related activities. No yard waste will be stored on-site with the possible exception of balled trees and bushes that have been prepared for installation. No retail or wholesale material will occur on site. No outdoor storage will take place and all equipment will be kept within a proposed building. No landscape waste will be stored on-site. No more than three (3) employees will be part of the operation.

The petitioner has indicated that much of the equipment used in the landscaping business is related to excavating including diggers, small and large, and dump trucks used to haul dirt for installation of plant material.

A 16,000sf building is proposed on the north end of the property to be used for storage of all equipment. This building will require a building permit.

The property has an existing access point onto Caton Farm with an asphalt drive. The submitted site plan proposes a widening of this drive on the subject property as well as within the R.O.W. of Caton Farm Road.

No parking is identified on the site plan. A proposed gravel area is located to the north of the site surrounding a proposed 16,000sf building. The petitioners have indicated that there will be no more than three (3) employees reporting to the site and that no wholesale or retail will be offered to the public. Staff is of the opinion that this gravel parking area will be adequate for employee parking. This gravel area and the proposed pond near it may require a stormwater management permit.

No lighting is proposed with the exception of a security light at the south edge of the proposed building.

A proposed non-lit free-standing sign is depicted at the southwest corner of the property along Caton Farm Road. This sign is subject to the requirements of Section 12 of the Zoning Ordinance and must be setback at least ten (10) feet from the edge of the ROW.

The Zoning Ordinance requires all vehicles, equipment and materials associated with a landscaping business shall be stored entirely within an enclosed structure, unless otherwise permitted under the terms of this Special Use Permit. The petitioner has indicated all equipment will be stored within the proposed building satisfying this requirement.

Attorney Dan Kramer stated that Chris and Megan Jensen operate a landscape business currently out of their home on East High Point Road. There are no employees that will report to the site. No landscape materials will be brought back to the site. The petitioners intend to plant nursery stock and trees but will have no retail or wholesale sales. Attorney Kramer stated that the existing house will not change uses and will maintain as a home. The proposed 16,000sf building will have maintenance performed in it. Mr. Rybski stated that a triple basin interceptor will be required for oil changes and as well as class V injection well. Bathrooms or water supply to the building will require a small septic system. The non-community well program will not be applicable given the low intensity of the property.

Mr. Chismark stated a field tile survey is required as part of the stormwater management permit submittal. Based on the area of disturbance stormwater detention will be required. Attorney Kramer stated that an engineer will be involved as the site plan progresses. An NRI executive summary report will be prepared.

Mr. Sterrett stated that this petition will be heard at the July 27<sup>th</sup> Plan Commission meeting.

Mr. Klaas made a motion, seconded by Mr. Gryder, to forward the petition onto the Plan Commission with a favorable recommendation. With a voice vote of all ayes, the motion carried.

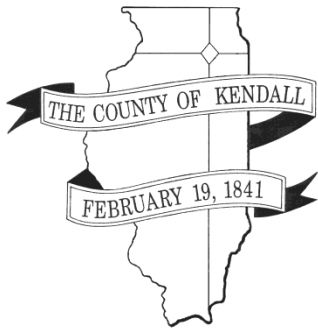

---

**DEPARTMENT OF PLANNING, BUILDING & ZONING**

111 West Fox Street • Room 204

Yorkville, IL • 60560

(630) 553-4141

Fax (630) 553-4179

**MEMORANDUM**

---

To: Kendall County Regional Plan Commission  
From: John H. Sterrett  
Date: July 19, 2016  
Re: Proposed Amendment to the Kendall County Land Use Plan

---

The Kendall County Planning, Building, and Zoning Department was approached by a property owner located at the northwest corner of State Route 31 and Light Road regarding a proposed expansion of an existing indoor self-service storage facility. The expansion would consist of the construction of a 8,400sf self-service storage building as well as a proposed outdoor storage area. The existing facility is zoned as B-2 (General Business) with a special use to operate the indoor self-service storage facility. The special use was granted for the indoor self-service storage facility in 1976. The parcel immediately to the south of the existing facility, where the expansion is proposed, is zoned as B-1 (Local Shopping). The B-1 district does not permit indoor self-service storage facilities nor does it allow outdoor storage either by right or by special use. The B-2 district allows for an indoor self-service storage facility as a conditional use and allows for outdoor storage as a special use. The property owner therefore will need to seek a rezoning of the current B-1 zoned property to B-2 for this expansion.

When reviewing proposed zoning map amendments, the County's Land Use Plan is taken into consideration to determine the proper zoning and uses for a specific area. The County's Land Use Plan currently identifies the subject area at the northwest corner of State Route 31 and Light Road as suburban residential (max density 1.00 du/acre). The existing zoning in the subject area consists of a mix of commercial zoning: B-1 (Local Shopping), B-2 (General Business), B-3 (Highway Commercial) with the existing uses of a gas station, a commercial strip mall, the self-service storage facility, a decommissioned water treatment facility, and stormwater detention facilities to serve these commercial uses. The area totals 10.5 acres.

Staff is of the opinion that given the existing zoning classifications and existing commercial uses in this area that the County's Land Use plan be amended to reflect commercial development for consistency with existing zoning and uses. Attached is a draft amendment to this portion of the Land Use Plan identifying the area as commercial. Per State Statute, a public hearing must take place as part of amending the County's Land Use Plan. This public hearing may occur at the next available Regional Plan Commission meeting in August.

Please review the attached and be prepared to provide comments on the proposed change to the Land Use Plan at the July 27, 2016 Plan Commission meeting.

JHS

Attachment

County Land Use Plan



County Zoning Map



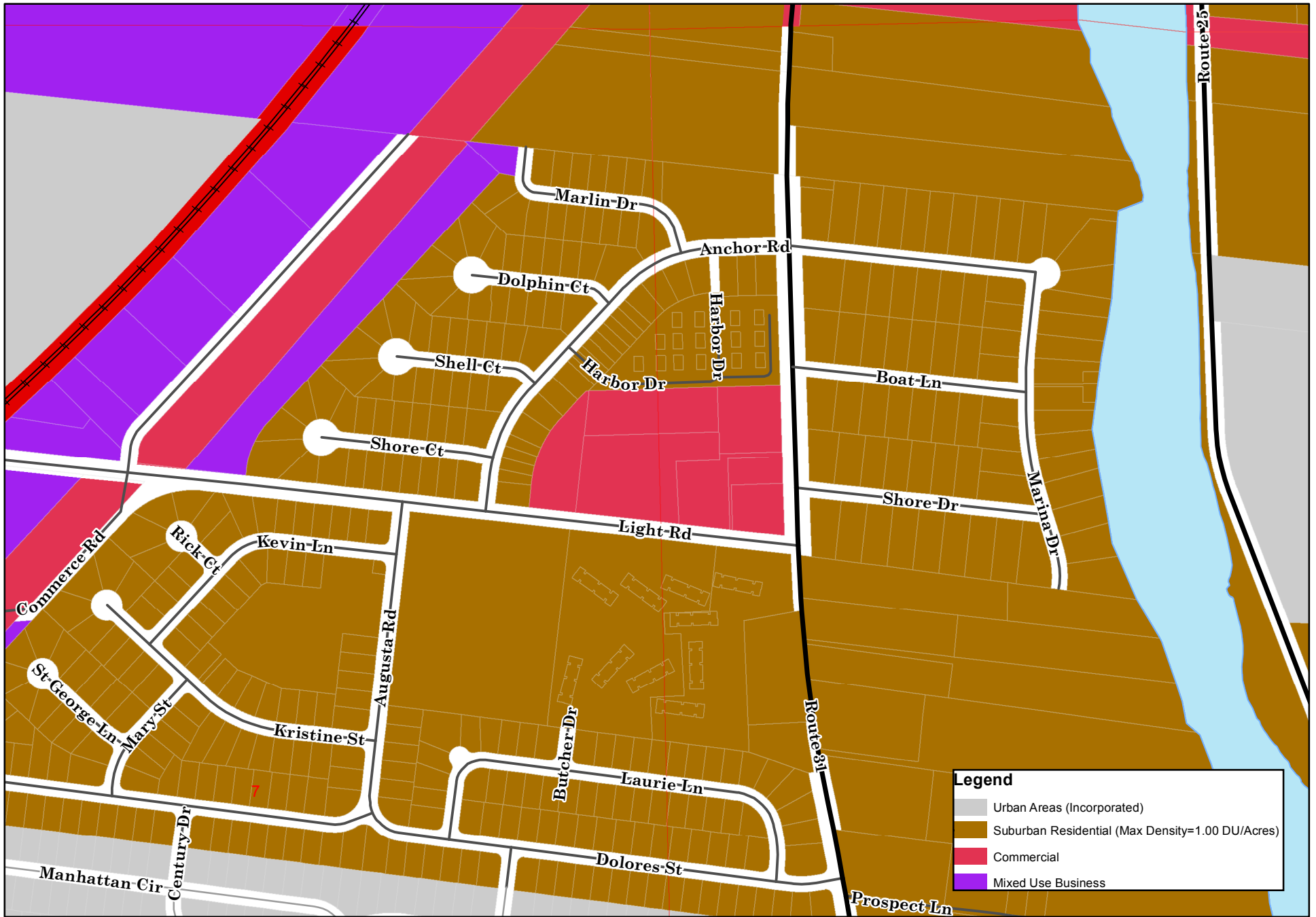

**Legend**

- Urban Areas (Incorporated)
- Suburban Residential (Max Density=1.00 DU/Acres)
- Commercial
- Mixed Use Business

0 265 530 1,060  
Feet

N



Kendall County GIS  
111 West Fox Street - Room 208  
Yorkville, Illinois 62458-1428  
618.433.4000

03-07-278-009, 03-07-278-010, 03-07-278-011,  
03-08-151-001, 03-08-151-002, 03-08-151-003, 03-08-151-004  
Oswego Township  
Kendall County Illinois

This work is provided as is, without warranty of any kind, either expressed or implied. The information represented may contain proprietary and confidential property of Kendall County Illinois. Under United States Copyright protection laws you may not use, reproduce, or distribute any part of this document without prior written permission. To obtain written permission please contact Kendall County GIS at 111 W Fox St, Yorkville, IL 620560.