

KENDALL COUNTY
ZONING AND PLATTING ADVISORY COMMITTEE
111 West Fox Street • Rooms 209 and 210 • Yorkville, IL • 60560
(630) 553-4141 Fax (630) 553-4179

AGENDA

July 12, 2016 - 9:00 a.m.

CALL TO ORDER

ROLL CALL: County Board: Scott Gryder, PBZ Committee Chair; **County Highway Department:** Fran Klaas, County Engineer; **Wills Burke Kelsey:** Greg Chismark, Stormwater Consultant; **County Health Department:** Aaron Rybski, Director Environmental Health; **Forest Preserve District:** David Guritz, Director; **SWCD:** Megan Andrews, Resource Conservationist; **Sheriff's Office:** Commander Mike Peters; **PBZ:** Brian Holdiman, Code Official; John Sterrett, Senior Planner

APPROVAL OF AGENDA

APPROVAL OF MINUTES: Approval of the May 3, 2016 ZPAC meeting minutes.

PETITIONS:

1. 16-14 Robert Delaney

Request: A-1 Special Use
Location: 16502 Church Road, Lisbon Township
Purpose: Request for approval of an A-1 Special Use to operate an outdoor shooting range

2. 16-16 Chris and Megan Jensen

Request: A-1 Special Use
Location: 7225 Caton Farm Road, Kendall Township
Purpose: Request for approval of an A-1 Special Use to operate a landscape and excavation business

REVIEW OF PETITIONS THAT WENT TO COUNTY BOARD

16-09 Joe Gomoll – A-1 Special Use for producing and selling products from items produced on and off-site and ancillary items – Approved by County Board 6.21.16
16-10 Whitetail Ridge – A-1 Special Use for Banquet Facility – Hearing Officer 7.7.16; PBZ 7.11.16

OLD BUSINESS/ NEW BUSINESS

PUBLIC COMMENT

ADJOURNMENT- Next meeting on August 2, 2016

**ZONING, PLATTING & ADVISORY COMMITTEE (ZPAC)
May 3, 2016 – Meeting Minutes**

Senior Planner John Sterrett called the meeting to order at 9:00 a.m.

Present:

Scott Gryder – PBZ Committee Chair
Fran Klaas – Highway Department
David Guritz- Forest Preserve
Commander Mike Peters – Sheriff's Office
Aaron Rybski – Health Department
Megan Andrews – Soil & Water Conservation District
John Sterrett – PBZ Department

Absent:

Greg Chismark – WBK Engineering, LLC
Brian Holdiman- PBZ Department

Audience: Joe Gomoll; Attorney Dan Kramer; Ron Walker

AGENDA

Mr. Gryder made a motion, seconded by Mr. Klaas, to approve the agenda as written. With a voice vote of all ayes the motion carried.

MINUTES

Mr. Gryder made a motion, seconded by Commander Peters, to approve the April 5, 2016 meeting minutes as written. With a voice vote of all ayes the motion carried.

PETITIONS

#16-09 – Joe Gomoll

Mr. Sterrett summarized the zoning request, which is a request for an A-1 Special Use for the production and sale of sweet cider, hard cider, wine, jams, wine jams, jellies, pies, pickles, honey, sauces and similar items utilizing crops grown on the same property or in combination with crops grown off-site where such production takes place on the premises and as well as the sales of ancillary items and products related to crops and products produced on site. The property is located at 10151 Lisbon Road in Fox Township. The petitioner will be operating the use out of an existing 4,800 square foot structure and utilizing 1,000 square feet of retail space. Five (5) parking stalls are proposed to meet the requirements of the zoning ordinance for this type of use. Staff is recommending approval of the special use request with the following conditions:

1. The property shall be developed in substantial compliance with the submitted site plan
2. Parking stalls reserved for ADA access shall be paved with a hard surface and identified as such
3. A change of occupancy permit shall be secured within sixty (60) days upon approval of the special use
4. All proposed signage shall comply with Section 12 of the Zoning Ordinance
5. No lighting associated with the use shall be installed
6. No alcohol shall be offered for retail sale on the property until such time that a liquor license is permitted to be issued in Fox Township and until said liquor license has been approved by Kendall County. All regulations of the Kendall County Liquor Control Ordinance shall be followed.
7. A temporary permit from the Health Department shall be secured prior to the sale of sweet cider

Mr. Rybski reiterated the provision for a temporary permit from the Health Department and that as the business grows the Health Department will provide information on any additional requirements. Mr. Klaas stated that if there any future additional ROW required along Lisbon Road that parking and building are setback far enough.

Mr. Gryder made a motion, seconded by Mr. Rybski, to forward the petition onto the May 25th Regional Plan Commission. With a voice vote of all ayes, the motion carried.

#16-10 – Whitetail Ridge

Mr. Sterrett summarized the zoning request, which is a request for an A-1 Special Use to operate a banquet facility on a 17 acre property located at 9111 Ashley Road in Kendall Township. Mr. Sterrett noted that any building being used for the operation will be required to obtain change of occupancy permits for basic life safety standards. The petitioner is proposing 72 parking stalls for the use. This would accommodate 288 patrons on the property, per the parking requirements of the zoning ordinance. Mr. Sterrett stated that additional information has been required with respect to the operation. A revised site plan must be submitted with correct dimensions for the proposed parking stalls and number of ADA accessible stalls. Attorney Kramer stated that no liquor license will be sought for the property and no alcohol will be sold. Mr. Rybski stated that parking over the septic area must be avoided. Mr. Rybski stated that the requirement for a non-community well program is close based on the frequency of events. Ron Walker stated that other events may occur on the property but the primary use will be for weddings. Ms. Andrews stated that an executive NRI summary will be prepared. Attorney Kramer stated that the petition will be reviewed by Kendall Township on April 17th.

Ms. Andrews made a motion, seconded by Mr. Gryder, to forward the petition onto the May 25th Regional Plan Commission. With a voice vote of all ayes, the motion carried.

#16-03 – Dumpsters in Residential Zoning Districts

Mr. Sterrett stated that this is a zoning text amendment that PBZ staff has been working with the PBZ Committee on to regulate dumpsters in residential zoning districts to prevent dumpsters from being permanently located in a residential zoning district. This topic was brought forward to the Committee after receiving complaints from residents about a dumpster on a property in an R-2 zoned subdivision. After discussion on the matter, the Committee felt that only dumpsters that are of a temporary nature for a specific timeframe and only for personal uses should be permitted to be located on residentially zoned properties. The Committee directed staff to draft provisions that deal with reasons and timeframes for what can be considered a temporary dumpster and for scenarios of when a property owner may have a dumpster on his or her property. The Committee believe that two scenarios exist when a dumpster may be permitted in all residentially zoned properties on a temporary basis - It is associated with an approved building permit for construction or remodeling of either a principal or accessory structure on a property. This does not include waste generated off-site, and when it is for temporary use by property owners not including waste generated off-site. Temporary Dumpsters shall not be kept on any residential property for more than 30 days within a 90 day period and no more than 60 days within a 12 month period unless the dumpster is associated with a building permit for construction or remodeling of either a principal or accessory structure on a property. In cases when a Temporary Dumpster is associated with an open and approved building permit, the Temporary Dumpster shall be permitted to be located on the property for the duration of the building permit provided that it is removed from the property once the permit has received a final inspection approval, or the building permit has expired, whichever occurs first.

The ZPAC recommended that the setback be changed from ten feet to five feet.

Mr. Rybski made a motion, seconded by Mr. Gryder, to forward the petition onto the May 25th Regional Plan Commission. With a voice vote of all ayes, the motion carried.

REVIEW OF PETITIONS THAT WENT TO COUNTY BOARD

16-05 – Treva and Brad Mathre – A-1 Special Use – Banquet Facility – 13889 Hughes Road. This petition received a favorable recommendation from the Plan Commission and the ZBA/Hearing Officer.

OLD BUSINESS

None

NEW BUSINESS

None

ADJOURNMENT

Mr. Klaas made a motion, seconded by Ms. Andrews, to adjourn. With a voice vote of all ayes, the motion carried. The ZPAC, at 9:41am, adjourned.

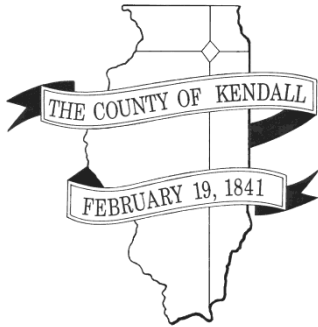

DEPARTMENT OF PLANNING, BUILDING & ZONING

111 West Fox Street • Room 203

Yorkville, IL • 60560

(630) 553-4141

Fax (630) 553-4179

Petition 16-16

Robert Delaney

A-1 Special Use – Outdoor Shooting Range

SITE INFORMATION

PETITIONER Robert Delaney

ADDRESS 16502 Church Road

LOCATION East side of Church Rd; 0.25 mi north of Whitewillow Road



TOWNSHIP Lisbon

PARCEL # 08-25-300-009; -006

LOT SIZE 38.49 acres

EXITING LAND USE Agricultural

ZONING A-1 Agricultural District

LRMP	Land Use	Agricultural
	Roads	Church Road is a township road classified as a non-Collector Road
	Trails	None

Floodplain/ Wetlands	Fresh water emergent wetlands exist on the northwest portion of the property
-------------------------	--

REQUESTED ACTION: A-1 Special Use to operate an outdoor shooting range

APPLICABLE REGULATIONS: Section 7.01 D.10 – A-1 Special Uses – Permits Outdoor Shooting Ranges to be located in the A-1 District with approval of a Special Use provided that certain requirements are met.

Section 13.08 – Special Use Procedures

SURROUNDING LAND USE

Location	Adjacent Land Use	Adjacent Zoning	Land Resource Management Plan	Zoning within 1/2 Mile
North	Agricultural	A-1	Agricultural	A-1
South	Agricultural	A-1	Agricultural	A-1
East	Agricultural/ComEd Transmission Lines	A-1	Agricultural	A-1
West	Agricultural/Residential	A-1	Agricultural	A-1

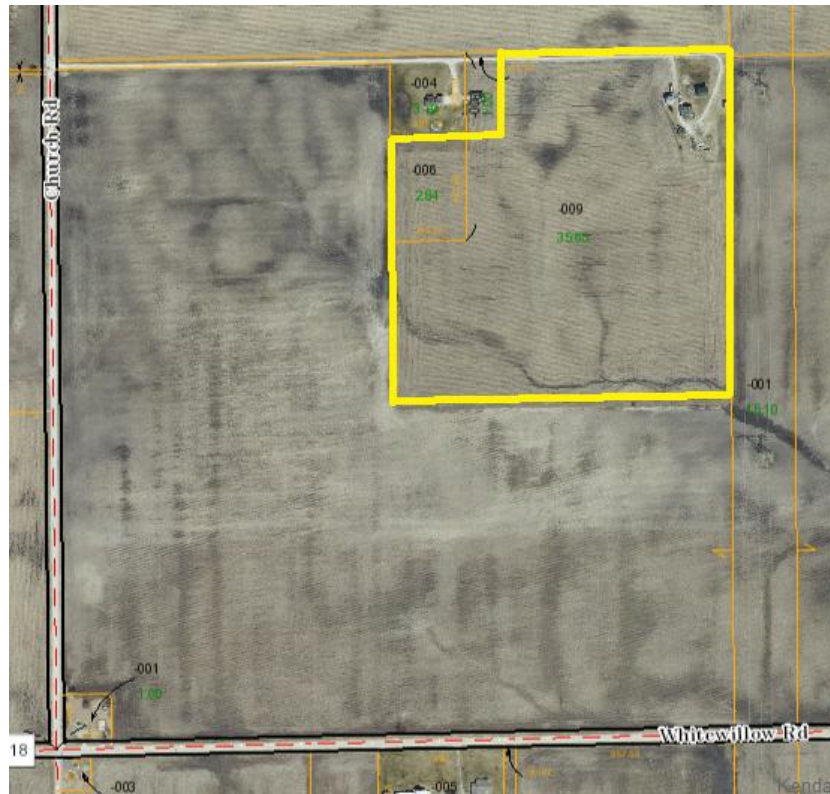

PHYSICAL DATA

ENDANGERED SPECIES REPORT

No Endangered or Threatened Species identified in the vicinity of the project area

NATURAL RESOURCES INVENTORY

None received. Required prior to RPC.

ACTION SUMMARY

LISBON TOWNSHIP

Petition information was sent to Lisbon Township 6.22.16. No comments have been received from Lisbon Township.

GENERAL

Robert Delaney is requesting an A-1 Special Use to operate an outdoor shooting range at the subject property. This type of use is permitted as a special use on an A-1 property with certain conditions. Those conditions include:

- a. Requires conformity with NRA standards; provide appropriate berming based on surrounding land use and type(s) of firearms to be used. Such as berming shall generally be consistent with standards established in the NRA Source Book.
- b. Requires minimum parcel size of 5 acres, depending on the venue.
- c. Must have a sign that lists allowed firearm types, rules of operation; hearing and vision protection required.
- d. State recognized, nationally recognized or NRA Certified range supervisor must be present
- e. Range flag flown, a sign or red light lit at all times that firing is taking place.
- f. Hours and days of operation as specified in the Special Use Permit to be determined by the County Board.
- g. Access must be controlled by a lockable gate.
- h. Hazardous waste plan addressing lead management required.
- i. No discharge of lead shot into wetland.
- j. Must be at least 1,000' from existing dwellings and property lines of schools, daycares, places of worship and airstrips.
- k. No alcohol allowed.
- l. No projectiles shall leave the boundaries of the site.
- m. All applicable Federal, State and County rules and regulations shall be adhered to.
- n. Must meet all requirements of the Kendall County Health Department
- o. Water and drainage plans must be approved by the Kendall County Planning, Building and Zoning Office.
- p. Signage is permitted but must meet the Sign Ordinance regulations of Section 12 of the Zoning Ordinance.
- q. Lighting shall meet the standards of Section 11.02.F.12.d of the Zoning Ordinance.
- r. Must adhere to the Performance standards of Section 10.01.F of the Zoning Ordinance

BUSINESS OPERATION

The petitioner has submitted a business plan outlining activities. Twenty-four (24) lanes are proposed for the range with an additional twelve (12) lanes proposed in the future that will have distances of seventy-five (75) feet. The range has a north-south orientation with the firing taking place towards the south. A thirty-four (34) foot wide earthen berm is proposed to serve as a backstop for the range as well as side-berming. The berm is proposed to be ten (10) feet in height on all sides and at the peak will have a flat portion of four (4) feet. The petitioner has indicated that this height may be increased. Per Section 3.04.5.1 of Article III, Section I, Chapter I of the NRA Range Source Book, the recommended height for a backstop is twenty (20) feet. As a future endeavor, the petitioner has discussed installing deflectors that would prevent any discharge from reaching an angle that would leave the parameters of the berm backstop. The distance from the edge of the backside of the backstop berm to the limits of the property is 950'. The eastern sideberm is located up to the ComEd property adjacent to the subject property.

A hazardous waste plan addressing lead management is required for outdoor shooting ranges. This plan has not been submitted and the petitioner has indicated they are working with local outfits to provide screening of the area for lead removal. This plan is a required document as part of the special use.

The hours of operation are proposed to be Tuesday thru Friday 10:00am to 8:00pm or until one-half hour before dusk, whichever is first, and Saturday and Sundays 9:00am to 8:00pm or until one-half hour before dusk, whichever is first. The range will be closed on Mondays. The petitioner has indicated that one (1) range safety official will be assigned for each twelve (12) lanes. The petitioner has submitted an exhibit on the site plan indicating a 1,000' buffer between the nearest residential dwelling unit and the edge of the shooting range. An outdoor shooting range is required to be located at least 1,000' from existing residential dwelling units.

HEALTH CODES

The petitioner is proposing to use one portable toilets for on site. A food truck is proposed for on-site. These

items must be evaluated and permitted through the Kendall County Health Department.

BUILDING CODES

A temporary range building with electric service is proposed. This building will need to be evaluated by the Building Department for determination of any required building permits.

ACCESS

The property is a landlocked parcel without direct access onto Church Road. The petitioner has informed staff that access to Church Road is obtained through an easement agreement for ingress and egress with property to the west of the subject parcel utilizing a private drive that serves the residential dwelling unit on the property to the west of the subject parcel.

PARKING

The site plan identifies thirty-six (36) parking stalls with two (2) of these as reserved for ADA compliance. The location and dimensions of these parking stalls meet the requirements of setbacks and width and depth. One (1) of the ADA stalls must be widened by eight (8) feet to create a 20'x16' stall.

LIGHTING

The petitioner has indicated that security lighting may be added around building and security gate. Staff recommend this lighting be shrouded to prevent glare onto adjacent properties.

SIGNAGE

Two (2) off-premises directional signs are proposed with one located at the northeast corner of the private drive and Church Road and one located at the southeast corner of Route 52 and Church Road. Off-premise signs are not permitted in the A-1 Agricultural District.

CONCLUSION

The proposed use of the property for an outdoor shooting range is considered permitted as a special use in the A-1 District with several required conditions outlined above including conformance with the standards of the NRA Range Source Book. Other conditions should be considered to mitigate any potential negative impacts an outdoor shooting range may have on surrounding properties and to address any potential environmental concerns with regards to lead. This includes the submission of a hazardous waste plan addressing lead management using the EPA Best Management Practices for Lead at Outdoor Shooting Range. Additional safety measures should be considered to prevent any projectiles leaving the boundaries of the site onto adjacent properties including an increase in height of the proposed berm to twenty (20) feet per the NRA Source Book and the installation of barriers designed to contain, deflect or fragment bullets to prevent any projectiles from leaving the site.

RECOMMENDATION

If approved, staff recommends the following conditions be placed on the controlling special use:

- The shooting range operation shall conform with NRA standards established in the NRA Source Book
- Berming shall be a minimum height of twenty (20) feet per the NRA Range Source Book
- A sign shall be installed that is visible to all visitors of the shooting range that lists allowed firearm types, rules of operation – hearing and vision protection required
- A State recognized, nationally recognized or NRA Certified range supervisor shall be present at all times
- A range flag, a sign, or red light shall be displayed at all times when firing is taking place
- Access to the shooting range shall be controlled by a lockable gate.
- Hazardous waste plan addressing lead management required with a lead removal occurring at least once a year
- Submission of a maintenance bond annually for removal of lead
- Submission of the types of firearms to be used
- No discharge of lead shall occur into any wetlands
- No alcohol shall be allowed
- Sunday hours of operation shall be limited to 12:00pm to 8:00pm, or until one-half hour before dusk
- Baffles shall be installed to prevent projectiles from leaving the boundaries of the site
- All applicable Federal, State and County rules and regulations shall be adhered to

- Must meet all requirements of the Kendall County Health Department
- A stormwater management permit shall be approved prior to the start of construction
- Proposed signage shall meet the requirements of Section 12 of the Zoning Ordinance
- Lighting shall meet the standards of Section 11.02.F.12.d of the Zoning Ordinance
- Must adhere to the Performance standards of Section 10.01.F of the Zoning Ordinance

ATTACHMENTS

1. Description of proposed use - prepared by the petitioners
2. Site Plan Drawings

"DIRT ROAD RANGE"
Operations Proposal

- Hours of ops: 0900--½ hour before dusk, 6 days/week (7th day for maintenance)
 - Hours: Tues-Fri 1000 to 2000 OR ½ hr before dusk, whichever is first, Sat & Sun is 0900 to 2000 OR ½ hr before dusk, Mon closed
 - Online calendar will refer to Almanac for sunset time
 - Options available to rent portion or all of range
 - Reserve 2 lanes for private lessons
 - Have guns available for rental and ammo for sale
 - Will require amended (add) address for FFA license
 - Host regular and special events
 - i.e. Tuesday night steel or have special guest instructor
- Main concern is education & safety while providing a facility that will be available to the shooting public and LEO's + FFD's
 - Membership available for additional benefits
 - Discounted range fees (1/2 price)
 - Discount on ammo, training (10%) + free membership to CRA
 - Annual fee at \$360
 - Weekdays: unlimited time, Weekends: 2 hour limit
 - Free shirt (contests for wearing shirt and posting on social media: maybe entered into raffle?)
 - Member appreciation days (guest instructors, guests, scenarios)
 - Multi-level? I.e. Gold vs Bronze
 - Food truck on site
 - Trucks pay for privilege of being on site (\$50/hour or \$250/day) Auction Sale %
 - Available during peak hours
 - Multiple trucks can be scheduled (they need permit from Kendall County)
 - Porta-potty Rental
 - Typically \$100-\$200/month (includes weekly maintenance)
 - May use one at first with multiple units with growth
- Scheduling by the shooters will be over an internet site that enables the participant to check on availability and self-schedule
 - Calendar options are Square, Bizzflo, as well as our current merchant processing system candidate (which offers a calendar scheduling app)
 - Other options: BookSimple, Booker
 - Some lanes will be designated for reservations and others left available for walk-ins (not listed on calendar site)
 - Ratio can change for peak times (accommodate for more walk-ins during busiest hours)
 - Website designed and optimized by CDG contactors
- Range mgmt will be conducted to the highest level of safety and comfort, range officials will be certified and are in full control of all Range Activities.
 - First Aid & CPR Cert for all EEs
 - Need to create in-house training for all range EEs that would reiterate NRA and any additional standards created by us

? \$ hourly rate

"DIRT ROAD RANGE"
Operations Proposal

- All 1st time shooters required to watch safety video (this is currently not standard for any known range), and annually for repeat customers
 - CDG will track safety video requirement electronically
 - Safety video will be produced by CDG contractors
- This is a new concept to our shooting community and will provide the best use for this isolated parcel
- LEO's will be able to use the range at their convenience at no charge *FFDO's*
 - Might be better to offer LEO/VET get ½ price on range fees—no other ranges in area offer totally free fees to LEO/VET's and few offer ½ price. This would still make us competitive.
 - VET and LEO get ½ price on membership (plus 1st time free) *FFDO's*
- We are thinking the total initial number of employees full-time and part-time at 10-12
 - 1 range safety per 12 lanes. Plus DR running the office. On weekends or peak times 1 or 2 additional personnel to assist with register and sales
 - Ex: 36 lanes on Saturday -- 6 persons total. 3 safety and 3 in office. Certain employees could rotate in office and on range duties
 - DR or JV to handle any transactions that need to be taken to Tom's for FFA (i.e.: any gun sales)
 - Reduce required RSO's by requiring 1st time shooters to watch 10-15 minute safety video (no direct competitor is doing this, but it is common in other industries such as skydiving, paintball and go karting).
- Sales of items to enhance safety will include safety glasses, ear plugs, ear muffs, bottled water and assorted non-alcoholic canned or bottled water and sodas.
 - We found out that FFA can't do business on the site for guns (until address change is registered with ATF), but all the non-firearm stuff is good to go
 - We could advertise for FFA's gun inventory on site, but buyers would have to physically travel to 14207 to actually transact any sales
- Operations on a daily basis will be managed and operated by CDG, a highly qualified group of Veterans of the Iraq and Afghanistan conflicts
- CDG will manage the range on a daily basis, with staff that is certified range management
 - Lighting, for security reasons, may be placed around office and gate on a timer. JV & DR to handle all end of shift procedures. Including lock-up and security of money.

CIVIL PLANS FOR DIRT ROAD RANGE MINOOKA, IL.

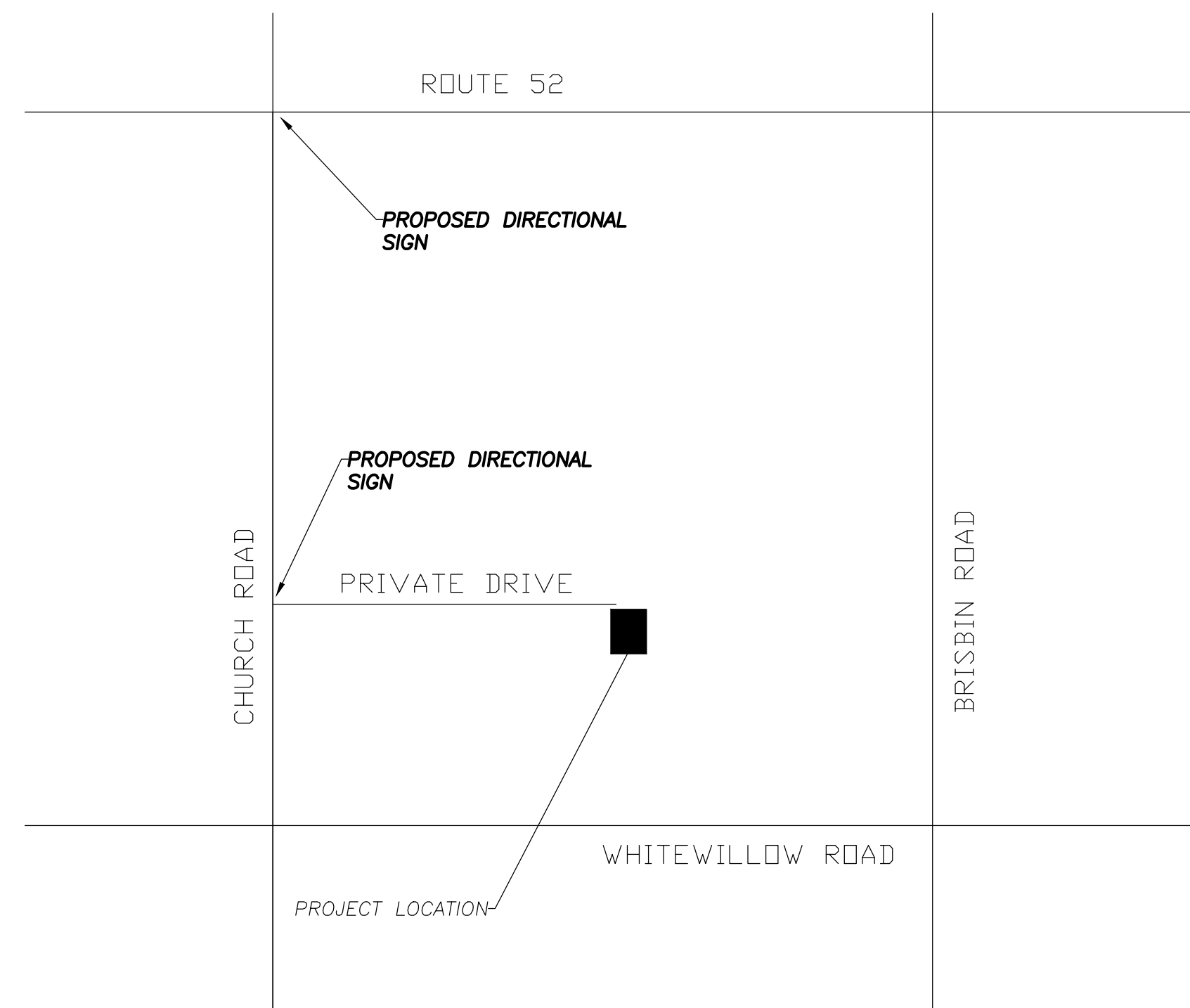

LOCATION PLAN

NO SCALE

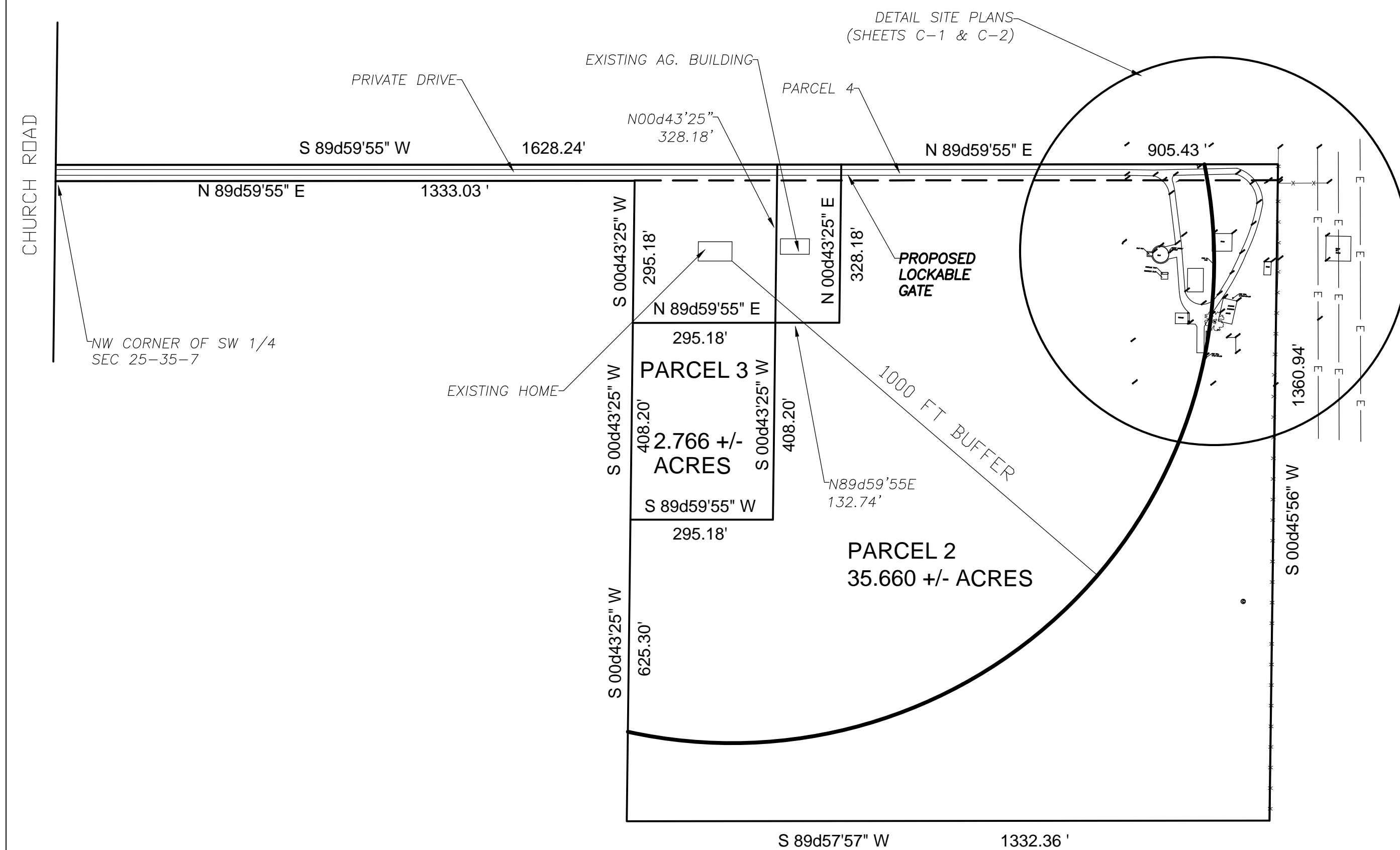

OVERALL SITE PLAN

1"=500'

LEGAL DESCRIPTION

PARCEL 2
THE NORTHEAST QUARTER OF THE SOUTHWEST QUARTER OF SAID SECTION 25, TOWNSHIP 35 NORTH, RANGE 7 EAST OF THE THIRD PRINCIPLE MERIDIAN, KENDALL COUNTY, ILLINOIS, AND ALSO A STRIP OF LAND 2 RODS WIDE OFF THE SOUTH SIDE OF THE SOUTH HALF OF THE NORTHWEST QUARTER OF SECTION 25, TOWNSHIP 35, RANGE 7 EAST OF THE THIRD PRINCIPLE MERIDIAN AND EXCEPTING THEREFROM BEGINNING AT THE NORTHWEST CORNER OF THE SOUTHWEST QUARTER SECTION 25; THENCE NORTH 89 DEGREES 59 MINUTES 55 SECONDS EAST ALONG THE NORTH LINE OF SAID SOUTHWEST QUARTER, 1333.03 FEET TO THE NORTHWEST CORNER OF THE NORTHWEST QUARTER OF SAID SOUTHWEST QUARTER; THENCE SOUTH 00 DEGREES 43 MINUTES 25 SECONDS WEST ALONG THE WEST LINE OF SAID NORTHWEST QUARTER, 703.30 FEET; THENCE NORTH 89 DEGREES 59 MINUTES 55 SECONDS EAST 295.18 FEET; THENCE NORTH 00 DEGREES 43 MINUTES 25 SECONDS EAST, 736.39 FEET TO THE NORTH LINE OF THE SOUTH 2 RODS OF THE SOUTH HALF OF SAID NORTHWEST QUARTER; THENCE SOUTH 00 DEGREES 41 MINUTES 00 SECONDS WEST 33.00 FEET TO THE POINT OF BEGINNING, FURTHER EXCEPTING THEREFROM THAT PART OF THE NORTHEAST QUARTER OF THE SOUTHWEST QUARTER OF SECTION 25 AND PART OF THE NORTHWEST QUARTER OF THE SECTION 25, ALL IN THE TOWNSHIP 35 NORTH, RANGE 7 EAST OF THE THIRD PRINCIPAL MERIDIAN, DESCRIBED AS FOLLOWS: COMMENCING AT THE NORTHWEST CORNER OF THE SOUTHWEST QUARTER OF SECTION 25; THENCE NORTH 89 DEGREES 59 MINUTES 55 SECONDS EAST ALONG THE NORTH LINE OF SAID SOUTHWEST QUARTER, 1333.03 FEET TO THE NORTHWEST CORNER OF THE NORTHEAST QUARTER OF THE SOUTHWEST QUARTER OF SAID SECTION 25; THENCE SOUTH 00 DEGREES 43 MINUTES 25 SECONDS WEST ALONG THE WEST LINE OF THE NORTHEAST QUARTER OF SAID SECTION 25, FOR A DISTANCE OF 295.18 FEET TO THE POINT OF BEGINNING; THENCE NORTH 00 DEGREES 43 MINUTES 25 SECONDS EAST, 328.18 FEET TO THE NORTH LINE OF THE SOUTH 2 RODS OF THE SOUTH HALF OF THE NORTHWEST QUARTER OF SAID SECTION 25, THENCE NORTH 89 DEGREES 59 MINUTES 55 SECONDS EAST ALONG NORTH LINE OF THE SOUTH 2 RODS OF THE SOUTH HALF OF THE NORTHWEST QUARTER OF SAID SECTION 25, 132.74 FEET TO THE POINT OF BEGINNING; ALL IN KENDALL COUNTY, ILLINOIS.

PARCEL 3
THAT PART OF THE NORTHWEST QUARTER OF THE SOUTHWEST QUARTER OF SECTION 25, TOWNSHIP 35 NORTH, RANGE 7, EAST OF THE THIRD PRINCIPLE MERIDIAN, DESCRIBED AS FOLLOWS: COMMENCING AT THE NORTHWEST CORNER OF THE SOUTHWEST QUARTER OF SAID SECTION 25, THENCE NORTH 89 DEGREES 59 MINUTES 55 SECONDS EAST ALONG THE NORTH LINE OF SAID SOUTHWEST QUARTER, 1333.03 FEET TO THE NORTHWEST CORNER OF THE NORTHEAST QUARTER OF THE SOUTHWEST QUARTER OF SAID SECTION 25, THENCE SOUTH 00 DEGREES 34 MINUTES 25 SECONDS WEST ALONG THE WEST LINE OF THE NORTHEAST QUARTER OF THE SOUTHWEST QUARTER OF SAID SECTION 25 FOR A DISTANCE OF 295.18 FEET TO THE BEGINNING; THENCE NORTH 89 DEGREES 59 MINUTES 55 SECONDS WEST 295.18 FEET, THENCE SOUTH 00 DEGREES 43 MINUTES 25 SECONDS WEST, 408.20 FEET, THENCE SOUTH 89 DEGREES 59 MINUTES 55 SECONDS WEST, 295.18 FEET TO THE WEST LINE OF THE NORTHEAST QUARTER OF THE SOUTHWEST QUARTER OF SAID SECTION 25; THENCE NORTH 00 DEGREES 43 MINUTES 25 SECONDS EAST ALONG THE WEST LINE OF THE NORTHEAST QUARTER OF THE SOUTHWEST QUARTER OF SAID SECTION 25, 132.74 FEET TO THE POINT OF BEGINNING, IN KENDALL COUNTY, ILLINOIS.

PARCEL 4
AN EASEMENT FOR INGRESS AND EGRESS ACROSS THE FOLLOWING DESCRIBED REAL ESTATE, THE SOUTH 33 FEET OF THE NORTHWEST QUARTER OF SECTION TOWNSHIP 35 NORTH, RANGE 7 EAST OF THE THIRD PRINCIPLE MERIDIAN, KENDALL COUNTY, ILLINOIS.

SITE TABLE (PARCELS 2 & 4)

DESCRIPTION	AREA IN SQUARE FEET	
	EXISTING	PROPOSED
BUILDINGS	5,590	755
* PARKING LOT	20,778	34,942
LOT SIZE	1,553,349	1,553,349
BUILDING COVERAGE (%)	0.36%	0.04%
** IMPERVIOUS COVERAGE (%)	1.70%	2.30%

MAXIMUM BUILDING COVERAGE = 60%

- * INCLUDES GRAVEL AND CONCRETE SLAB AREAS
- ** INCLUDES BUILDINGS, GRAVEL AND CONCRETE SLAB AREAS

PLAN SHEET INDEX

- C-1 TITLE SHEET
- C-2 SITE PLAN
- C-3 GRADING PLAN

ZONING INFO

THE SUBJECT PARCELS ARE DETERMINED TO BE CURRENTLY ZONED AS:
A-1 AGRICULTURE

PROPERTY INFO

P.I.N. : 08-25-300-007-008

COMMONLY KNOWN AS:

16502 CHURCH ROAD
MINOOKA, IL 60447

FLOOD ZONE INFO

THE SUBJECT PARCELS ARE DETERMINED TO BE OUTSIDE THE LIMITS OF THE 100-YEAR FLOODPLAIN PER KENDALL COUNTY FLOOD INSURANCE MAP NO. 17093C0200 G, PANEL 200 OF 225, EFFECTIVE FEBRUARY 4, 2009.

BENCHMARKS

ELEVATION = 694.05

SITE BENCHMARK

MASONRY CUT NAIL IN THE SOUTH FACE OF POWER POLE AT NORTHWEST CORNER OF THE PROJECT SITE AT THE INTERSECTION OF PRIVATE ROAD AND THE WEST DRIVEWAY ENTRANCE
ELEVATION = 693.42

GENERAL NOTES

- REFERENCED PLAT OF SURVEY BY MORRISON SURVEYING COMPANY, INC. DATED 10/26/14
- TOPOGRAPHIC SURVEY PERFORMED BY JCK ENGINEERS & BUILDERS, INC. 5/11/16
- EROSION CONTROL TO BE APPLIED PER THE ILLINOIS URBAN MANUAL, LATEST EDITION.

J.U.L.I.E. INFORMATION

NOTIFY J.U.L.I.E 2 WORKING DAYS PRIOR TO EXCAVATION
1-800-892-0123

COUNTY: KENDALL
MUNICIPALITY: MINOOKA, IL. 60447
LOCATION: N.E. 1/4 OF S.W. 1/4 SECTION 25, T. 35N. R.7E.
TOWNSHIP: LISBON
ADDRESS: 16502 CHURCH ROAD

JAMIE L. BRADLEY
ILLINOIS LICENSE # 062-049261
EXPIRES 11/30/17

NO.	REVISIONS	DATE	BY
1			

TITLE PAGE

MINOOKA, ILLINOIS
106 FORD DRIVE
Storage Building & Site Improvements

DIRT ROAD
RANGE

JCK
ENGINEERS & BUILDERS, INC.
450 WEST FIRST STREET
BRAIDWOOD, IL. 60408
(815) 458-0684
jckengbldr@yahoo.com

DATE:	5-9-16
SCALE:	AS SHOWN
DRAWN:	JLB
CHECK:	CK
JOB:	16-003
SHEET	

C-1

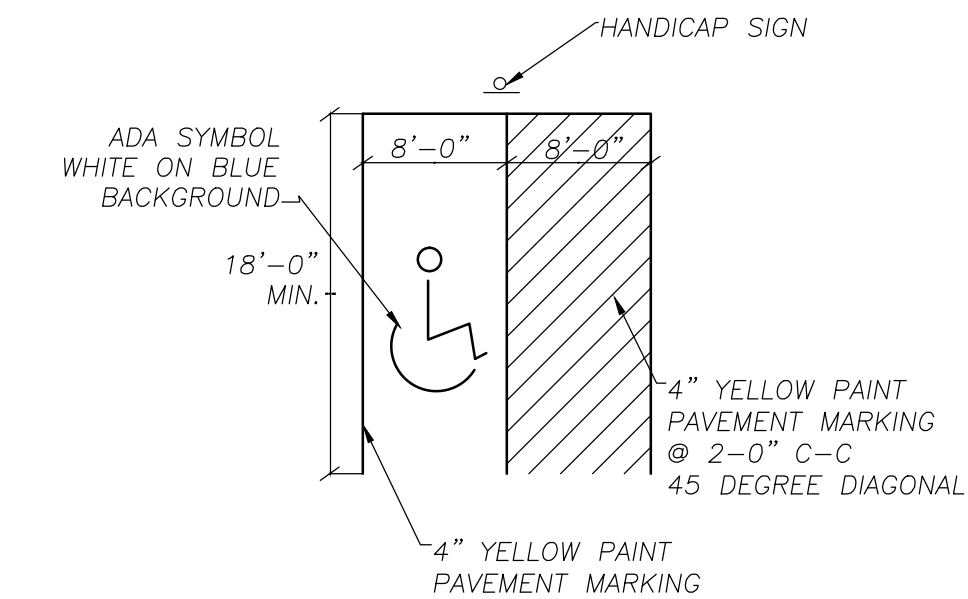
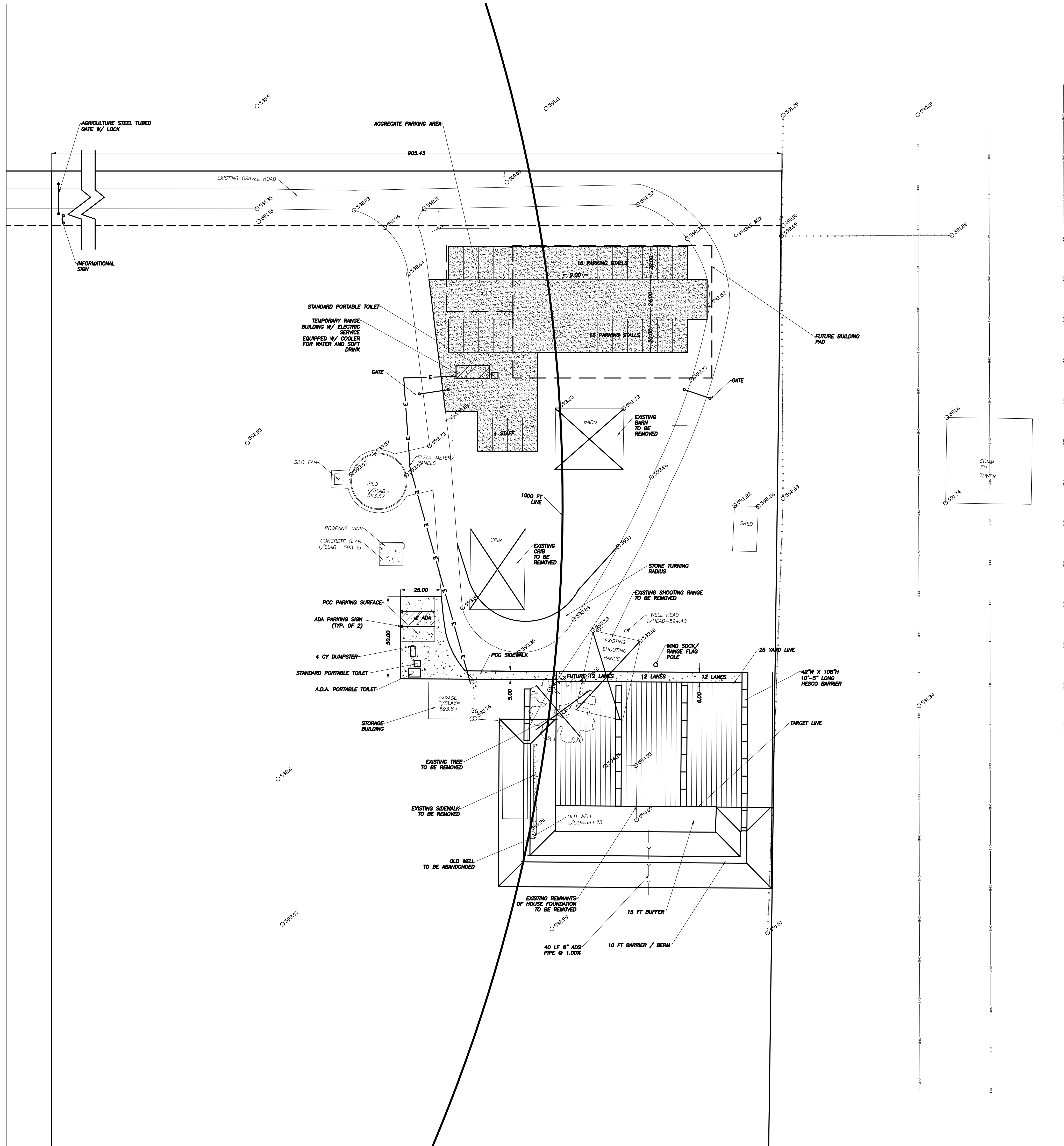

HANDICAP PARKING STALL
NOT TO SCALE

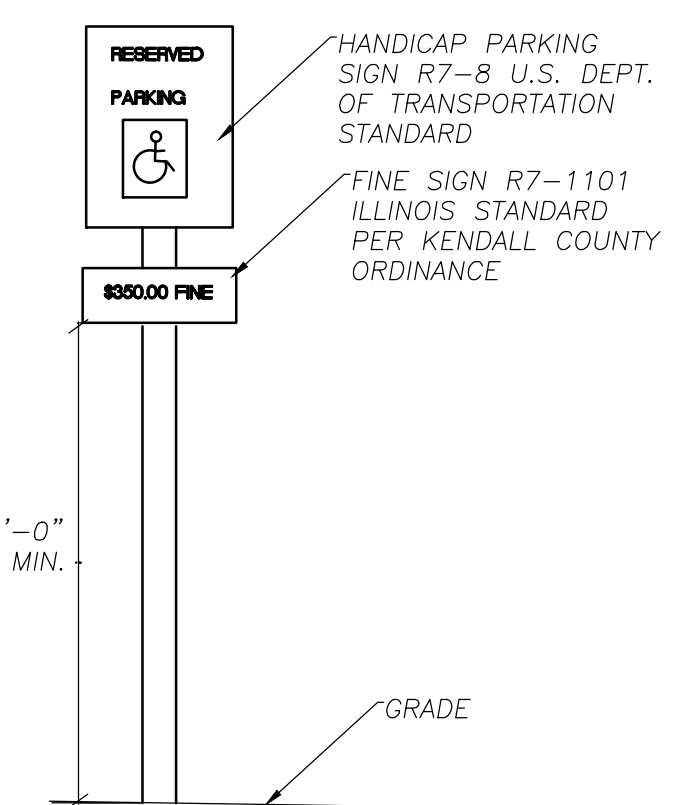

HANDICAP SIGN DETAIL
NOT TO SCALE

NORTH
SCALE 1"=30'

KEY

- EXISTING DECIDUOUS TREES
- EXISTING FENCE
- EXISTING STORM SEWER
- EXISTING OVERHEAD WIRE
- EXISTING ELECTRIC
- EXISTING WATER
- EXISTING WATER WELL
- EXISTING CONCRETE
- EXISTING PUBLIC UTILITY POLE
- PROPOSED REMOVAL ITEMS
- PROPOSED STORM SEWER
- PROPOSED PCC CONCRETE
- PROPOSED AGGREGATE PARKING

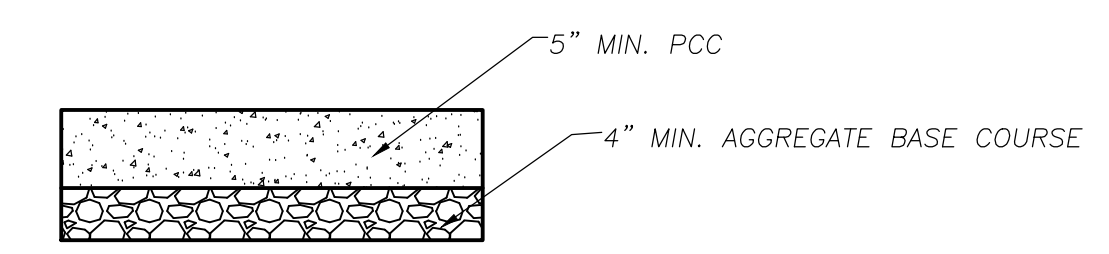

PROPOSED PCC SIDEWALK
NOT TO SCALE

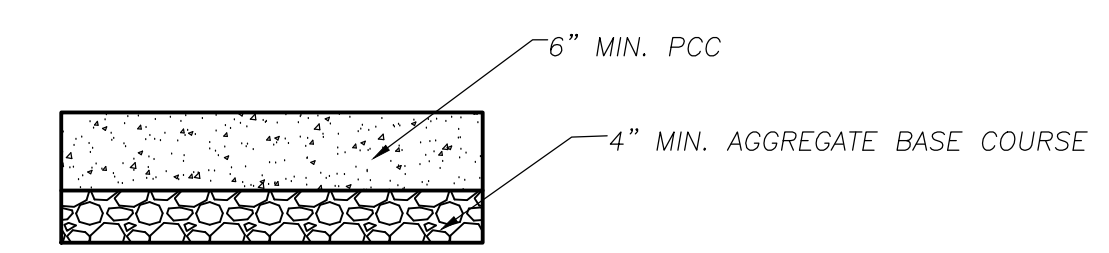

PROPOSED PCC PARKING
NOT TO SCALE

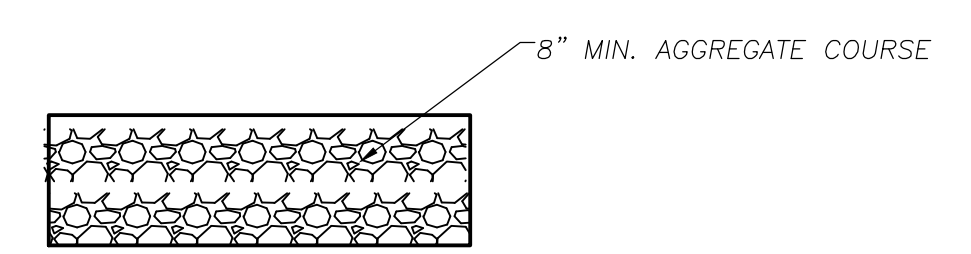

PROPOSED AGGRGATE PARKING
NOT TO SCALE

PARKING TABLE:

	PROPOSED	REQUIRED
4 EMPLOYEES		
PARKING STALLS	36	34
ADA PARKING STALLS	2	2
TOTAL STALLS	38	36

NO.	REVISIONS	DATE	BY

SITE PLAN

MINOOKA, ILLINOIS
CHURCH ROAD
Site Improvements

DIRT ROAD RANGE

JCK
ENGINEERS & BUILDERS, INC.
450 WEST FIRST STREET
BRADWOOD, IL 60408
(815) 458-0684
jckengbldr@yahoo.com

DATE:	5-9-16
SCALE:	AS SHOWN
DRAWN:	JLB
CHECK:	CK
JOB:	16-003
SHEET:	C-2

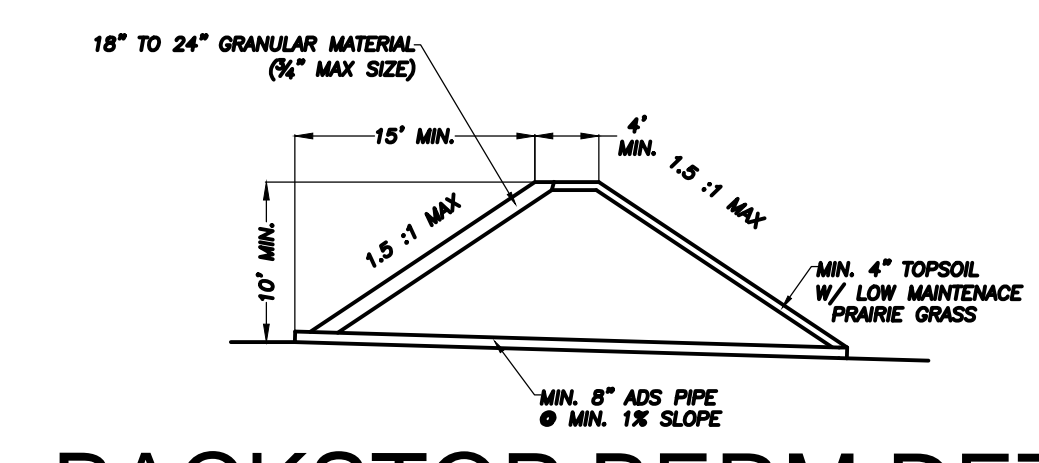
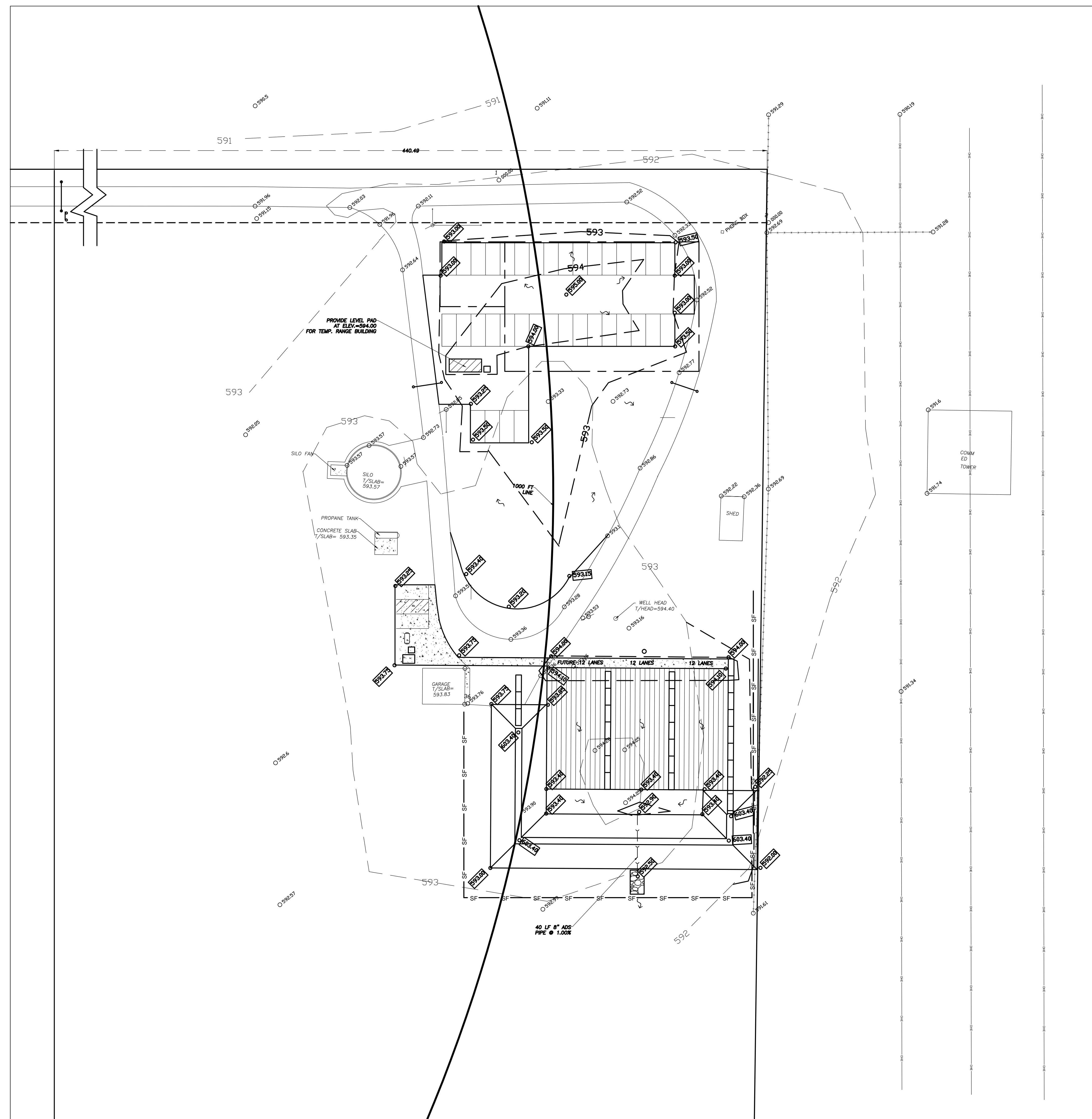

NORTH
SCALE 1"=30'

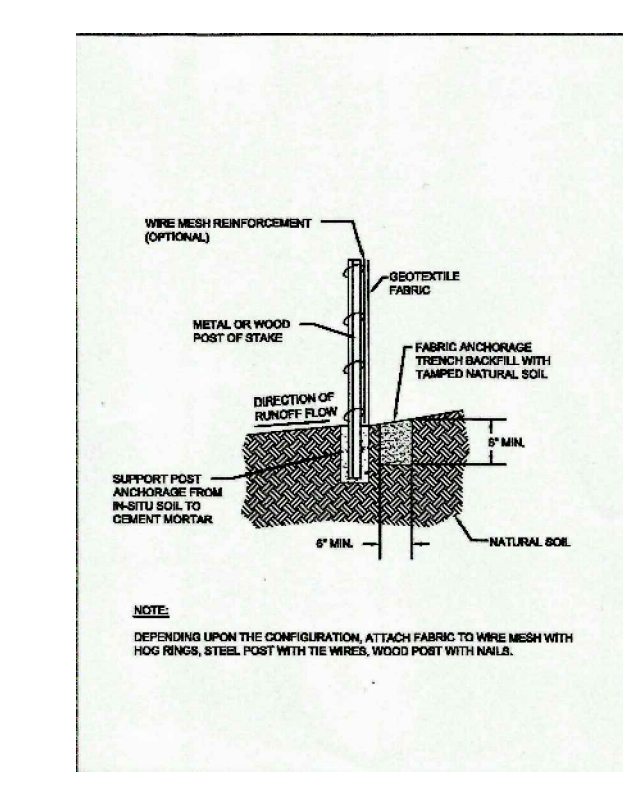

KEY

- — — — — EXISTING FENCE
- — — — — EXISTING STORM SEWER
- — — — — EXISTING OVERHEAD WIRE
- — — — — EXISTING ELECTRIC
- — — — — EXISTING WATER
- — — — — EXISTING WATER WELL
- — — — — EXISTING CONCRETE
- — — — — EXISTING PUBLIC UTILITY POLE
- — — — — EXISTING PUBLIC UTILITY POLE
- — — — — EXISTING CONTOUR
- — — — — PROPOSED REMOVAL ITEMS
- — — — — PROPOSED STORM SEWER
- — — — — PROPOSED SILT FENCE
- — — — — PROPOSED INLET FILTER
- — — — — PROPOSED FLOW ARROW
- — — — — PROPOSED PCC CONCRETE
- — — — — PROPOSED GRADE
- — — — — PROPOSED CONTOUR
- — — — — PROPOSED PCC CONCRETE

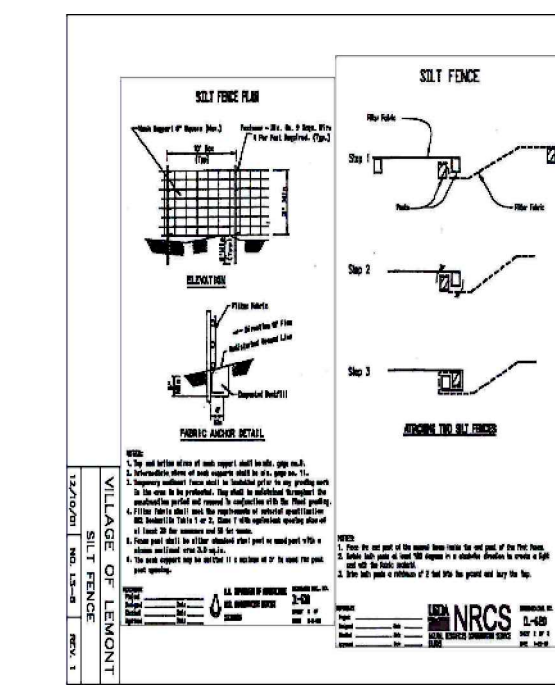

JCK
ENGINEERS & BUILDERS, INC.
450 WEST FIRST STREET
BRADWOOD, IL. 60408
(615) 458-0684
jckengbltrs@yahoo.com

GRADING PLAN

MINOOKA, ILLINOIS
CHURCH ROAD
Site Improvements

DIRT ROAD RANGE

DATE: 5-9-16
SCALE: AS SHOWN
DRAWN: JLB
CHECK: CK
JOB: 16-003
SHEET: C-3

NO.	REVISIONS	DATE	BY

©

COPYRIGHT 2016 JCK ENGINEERS & BUILDERS, INC.

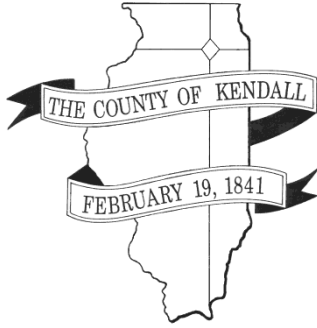

DEPARTMENT OF PLANNING, BUILDING & ZONING

111 West Fox Street • Room 203

Yorkville, IL • 60560

(630) 553-4141

Fax (630) 553-4179

Petition 16-16

Megan and Chris Jensen

A-1 Special Use – Landscape/Excavating Operation

SITE INFORMATION

PETITIONER Megan and Chris Jensen

ADDRESS 7225 Caton Farm Road

LOCATION North side of Caton Farm Road; 0.20 mi west of Church Road



TOWNSHIP Kendall

PARCEL # 05-26-400-004; Pt 05-26-400-005

LOT SIZE 7.58 acres

EXITING LAND Residential/Agricultural
USE

ZONING A-1 Agricultural District

LRMP	Land Use	Rural Estate Residential (Max Density=0.45 DU/AC)
	Roads	Caton Farm Road is a County road classified as a Major Collector Road
	Trails	None
	Floodplain/Wetlands	No floodplain or wetlands exist on the property

**REQUESTED ACTION
APPLICABLE REGULATIONS**

A-1 Special Use to operate a landscaping and excavating business

Section 7.01 D.28 – A-1 Special Uses – Permits Landscape Businesses with the following stipulations:

1. All vehicles, equipment and materials associated with a landscaping business shall be stored entirely within an enclosed structure, unless otherwise permitted under the terms of this Special Use Permit.
2. The business shall be located on, and have direct access to, a State, County or Collector Highway as identified in the County's LRMP, having an all-weather surface, designed to accommodate loads of at least 73,280 lbs, unless otherwise approved in writing by the agency having jurisdiction over said Highway. Such approvals shall establish limitations as to the number of employees and types of vehicles coming to and from the site that are engaged in the operation of the use (including delivery vehicles). These restrictions shall be included as controlling conditions of the Special Use. (Amended 7/17/2007)
3. No landscape waste generated off the property can be burned on this site

Section 13.08 – Special Use Procedures

Excavating operations are not permitted in the A-1 Agricultural as a special use

SURROUNDING LAND USE

Location	Adjacent Land Use	Adjacent Zoning	Land Resource Management Plan	Zoning within ½ Mile
North	Agricultural	A-1	Rural Estate Res.	A-1
South	Agricultural/Residential	A-1	Rural Estate Res.	A-1
East	Agricultural/	A-1	Rural Estate Res.	A-1; A-1 SU
West	Agricultural/Residential	A-1	Rural Estate Res.	A-1; A-1 SU



PHYSICAL DATA

ENDANGERED SPECIES REPORT

A corrected EcoCAT report must be submitted prior to RPC

NATURAL RESOURCES INVENTORY

None received. Required prior to RPC.

ACTION SUMMARY

KENDALL TOWNSHIP

Petition information was sent to Kendall Township 6.24.16. No comments have been received from Kendall Township.

GENERAL

Chris and Megan Jensen are requesting an A-1 Special Use to operate a landscaping and excavating business at the subject property. A landscape operation is permitted as a special use on an A-1 property with certain conditions. Those conditions include:

1. All vehicles, equipment and materials associated with a landscaping business shall be stored entirely within an enclosed structure, unless otherwise permitted under the terms of this Special Use Permit.
2. The business shall be located on, and have direct access to, a State, County or Collector Highway as identified in the County's LRMP, having an all-weather surface, designed to accommodate loads of at least 73,280lbs, unless otherwise approved in writing by the agency having jurisdiction over said Highway. Such approvals shall establish limitations as to the number of employees and types of vehicles coming to and from the site that are engaged in the operation of the use (including delivery vehicles). These restrictions shall be included as controlling conditions of the Special Use. (Amended 7/17/2007)
3. No landscape waste generated off the property can be burned on this site

An excavation operation is not permitted as a special use in the A-1 Agricultural District.

BUSINESS OPERATION

The operation will include landscape maintenance, installation of landscaping, and related activities. No yard waste will be stored on-site with the possible exception of balled trees and bushes that have been prepared for installation. No retail or wholesale material will occur on site. No outdoor storage will take place and all

equipment will be kept within a proposed building. No landscape waste will be stored on-site. No more than three (3) employees will be part of the operation.

The petitioner has indicated that much of the equipment used in the landscaping business is related to excavating including diggers, small and large, and dump trucks used to haul dirt for installation of plant material.

BUILDING CODES

A 1,600sf building is proposed on the north end of the property to be used for storage of all equipment. This building will require a building permit.

ACCESS

The property has an existing access point onto Caton Farm with an asphalt drive. The submitted site plan proposes a widening of this drive on the subject property as well as within the R.O.W. of Caton Farm Road.

PARKING

No parking is identified on the site plan. A proposed gravel area is located to the north of the site surrounding a proposed 16,000sf building. The petitioners have indicated that there will be no more than three (3) employees reporting to the site and that no wholesale or retail will be offered to the public. Staff is of the opinion that this gravel parking area will be adequate for employee parking. This gravel area and the proposed pond near it may require a stormwater management permit.

LIGHTING

No lighting is proposed with the exception of a security light at the south edge of the proposed building.

SIGNAGE

A proposed non-lit free-standing sign is depicted at the southwest corner of the property along Caton Farm Road. This sign is subject to the requirements of Section 12 of the Zoning Ordinance and must be setback at least ten (10) feet from the edge of the ROW.

SCREENING

The Zoning Ordinance requires all vehicles, equipment and materials associated with a landscaping business shall be stored entirely within an enclosed structure, unless otherwise permitted under the terms of this Special Use Permit. The petitioner has indicated all equipment will be stored within the proposed building satisfying this requirement.

CONCLUSION

The proposed use of the property for a landscaping operation is considered permitted as special use in the A-1 District with certain requirements. An excavating operation, however, is not considered permitted as a special use in the A-1 District.

RECOMMENDATION

If approved, staff recommends the following conditions be included in the approving special use ordinance:

1. All vehicles, equipment and materials associated with a landscaping business shall be stored entirely within an enclosed structure, unless otherwise permitted under the terms of this Special Use Permit
2. No landscape waste generated off the subject property may be burned on the subject property
3. A building permit shall be applied for and approved prior to the construction of the proposed building
4. All required site development permits shall be applied for and approved prior to start of construction
5. Proposed signage shall require a building permit and be subject to the sign requirements of Section 12 of the Zoning Ordinance.

A corrected EcoCat must be submitted as well as the results of an NRI report.

ATTACHMENTS

1. Zoning Plat
2. Letter to PBZ 7.7.16

LAW OFFICES
OF

Daniel J. Kramer

1107A SOUTH BRIDGE STREET
YORKVILLE, ILLINOIS 60560
(630) 553-9500
Fax: (630) 553-5764

DANIEL J. KRAMER

**KELLY A. KRAMER
D.J. KRAMER**

July 7, 2016

John Sterrett
Kendall County PB & Z
111 W. Fox Street
Yorkville, IL 60560

RE: Chris Jensen Landscaping Special Use

Dear John:

In regard to the June 24, 2016 Letter you sent I can provide the following information:

Description of Proposed Use

1. Much of the equipment used in his landscaping business is in fact related to excavating. He has small diggers, larger digger, dump trucks and the like to haul dirt for installation of plant material and the like. That's why we included the description of the excavation so that people knew that in regard to landscaping there is some machinery involved. We feel that is related to the landscaping and nursery use in that he plans to also plant a substantial numbers of trees and berming on the subject property subject to getting a site development permit. Hopefully that provides an answer to this question.
2. In regard to the operation he does landscape maintenance, installation of landscaping, and related activities. No yard waste will be stored on-site just perhaps balled trees and bushes ready for installation further there will be no retail or wholesales of materials at the site.

The building he purposes to use will allow for the complete storage of all equipment indoor and he will not provide any outdoor storage for vehicles, equipment, and the like.

He stores no landscape waste on-site and doesn't in his current home business that he is the sole operator together with his wife.

They would not expect at any time to have more than 3 employees.

3. The workshop internal in the building would be for storage of equipment when not being used, office, and repair area within the building.
4. We believe we have both parcel 1 and parcel 2 as part of the zoning application if we don't please consider both parcels and pin numbers 05-26-400-004 and 05-26-400-005 as part of the Petition. The reason that parcel 1 needs to be included is the fact that it contains the driveway to the rear of parcel 2 which is where the actual Special Use will be located is both parcels one and two are going to be acquired from Mr. and Mrs. Jensen from Jean Freeman. While she holds Title to parcel 1 in her individual name she is also the sole beneficiary of the Grundy County Trust that owns parcel 2 and has consented to the Zoning Special Use Request. If you need a letter from her in addition to the Application she signed and I will be happy to provide it.
5. I believe we have answered above, there should not be a need for ADA accessibility parking although again on the gravel surface we can add a sign for in that because of the strenuous nature of the work it would be very difficult to have a handicapped employee.
6. The only lighting that would be proposed would be a security light at the south edge of the building being constructed. There would be no lit sign although we would propose a low level landscape sign immediately to the east of the driveway out of the right-of-way at Caton Farm Road as shown on the plan.
7. We believe we have provided the answer to storage within the enclosed structure.

Other

I don't know how IDNR EcoCat came up with the Fox Township location in that the parcel is clearly located in Kendall Township pretty much to the middle and has Kendall Township Pin Numbers we will contact IDNR and ask them to revisit and send a correct aerial.

Should you have any questions or concerns please feel free to contact me.

Very truly yours,

Daniel J. Kramer,
Attorney at Law

DJK/cth

ZONING PLAT OF PART OF THE SOUTHEAST QUARTER OF SECTION 26, T36N-R7E, 3rd P.M. KENDALL TOWNSHIP KENDALL COUNTY ILLINOIS

LEGAL DESCRIPTION OF TRACT TO BE REZONED:

LEGAL DESCRIPTION OF PARCEL ONE:

The South 660.00 feet of the West 330.00 feet of the East Half of the Southeast Quarter of Section 26, Township 36 North, Range 7 East of the Third Principal Meridian, in the Township of Kendall Kendall County, Illinois, (EXCEPTING therefrom that part described as follows: Commencing at the Southwest Corner of the East Half of said Southeast Quarter; thence Easterly along the South Line of said Southeast Quarter, 215.0 feet for a point of beginning; thence continuing Easterly along said South Line, 115.0 feet to the East Line of the West 330.00 feet of the East Half of said Southeast Quarter; thence Northerly along said East Line, 393.39 feet; thence Southwesterly, 274.98 feet to a point that is 144.55 feet North of the point of beginning on a Line drawn parallel with the East Line of the West 330.00 feet of said Southeast Quarter; thence Southerly along said parallel line, 144.55 feet to the point of beginning).

LEGAL DESCRIPTION OF PARCEL TWO:

The South 1056.01 feet (EXCEPTING therefrom the South 660.00 feet) of the West 330.00 feet of the East Half of the Southeast Quarter of Section 26, Township 36 North, Range 7 East of the Third Principal Meridian, in the Township of Kendall Kendall County, Illinois.

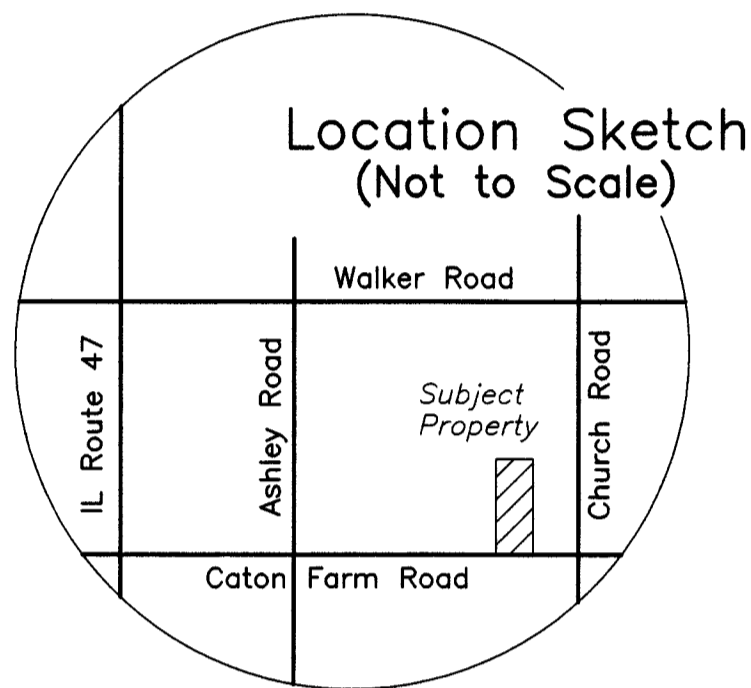

SOILS (From USCS Soils Map)

- 145B** Saybrook Silt Loam, 2 to 5% slopes
- 145C2** Saybrook Silt Loam, 5 to 10% slopes, eroded
- 152A** Drummer Silty Clay Loam, 0 to 2% slopes

AREA TO BE REZONED:

7.2898 Acres
(7.0430 Acres Excluding Roads)

PRESENT ZONING:

A1

PROPOSED ZONING:

A1-SU (Excavating Landscape)

DEVELOPER:

Chris and Megan Jensen
8751 East Highpoint Road, Suite C
Yorkville, Illinois 60560

N

SCALE
1"=40'

- Indicates Iron Stake Found
- Indicates Iron Stake Set
- Indicates Line of Fence
- 653— Indicates Contour Elevation

NOTE: This property is commonly known as 7225 Caton Farm Road.

P.I.N. 05-26-400-004
05-26-400-005

BENCHMARKS - (NGVD1929)

- BM#1 - Cross in Concrete Trim at Southeast Corner of Barn Elevation = 656.17
- BM#2 - Magnail in Asphalt Drive West of Brick and Frame Residence Elevation = 658.10
- BM#3 - Magnail in Pavement at Southwest Corner of Property Elevation = 651.47
- BM#4 - Magnail in Pavement at Southeast Corner of Property Elevation = 648.86

State of Illinois } SS
County of Kendall }

I, Phillip D. Young, an Illinois Professional Land Surveyor and an officer of Phillip D. Young and Associates, Inc., state that I have surveyed and located the visible improvements upon the attached described tract as shown by the plat hereon drawn which is a representation of said survey. Field work completed May 12, 2016. This professional service conforms to the current Illinois minimum standard for a boundary survey.

Dated May 17, 2016 at Yorkville, Illinois

Phillip D. Young
Phillip D. Young
Illinois Professional Land Surveyor No. 2678 (Expires 11/30/16)

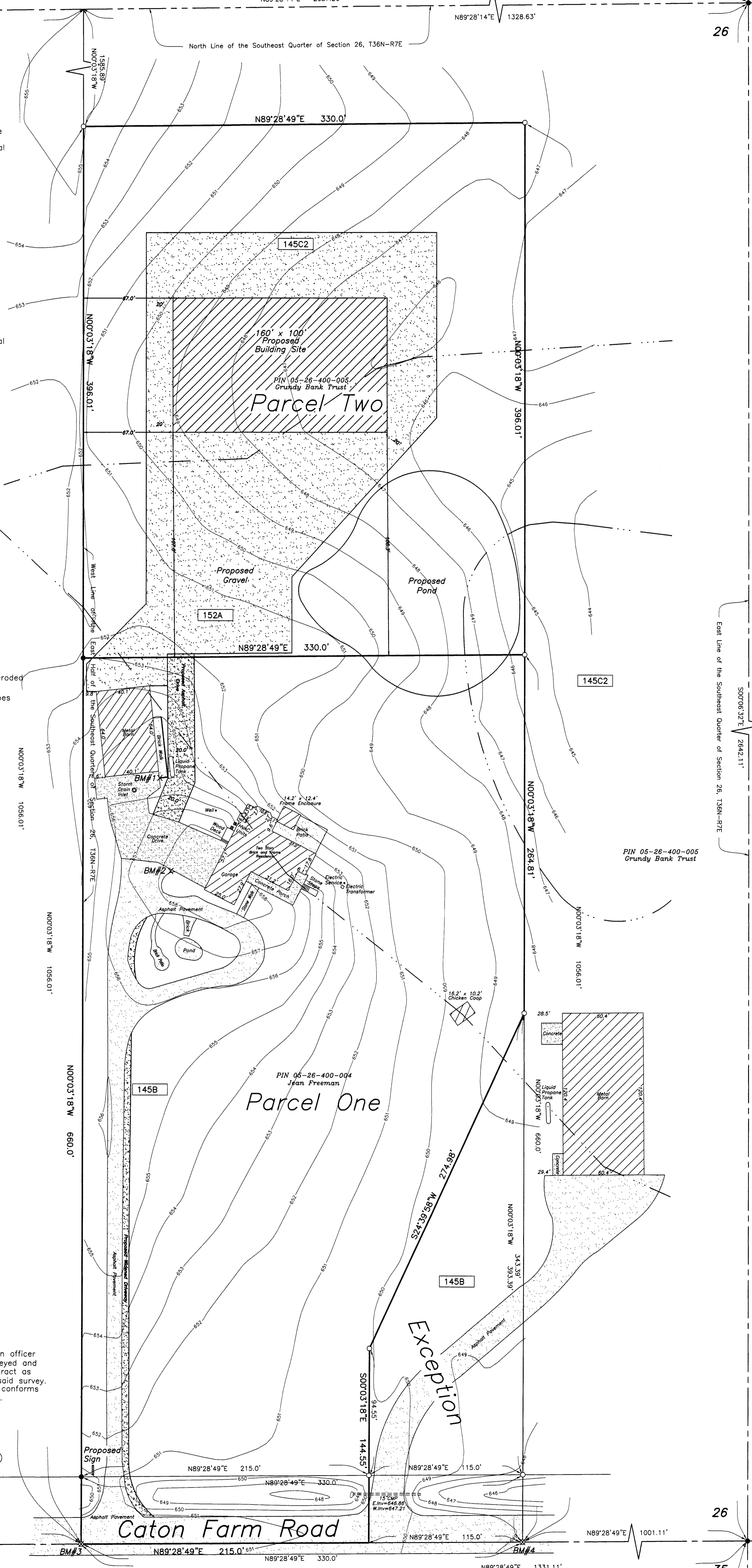

JOB NO.	16073
JOB NAME	JENSEN
DWG FILE	16073B
REVISION DATE	

Phillip D. Young and Associates, Inc.
LAND SURVEYING - TOPOGRAPHIC MAPPING - Lic.#184-002775

1107B South Bridge Street
Yorkville, Illinois 60560
Telephone (630)553-1580