

KENDALL COUNTY        )  
  )  
STATE OF ILLINOIS        )

ORDINANCE NO. 2010- 17

**KENDALL COUNTY HISTORIC PRESERVATION GUIDELINES FOR  
PRESERVATION, RESTORATION, REHABILITATION AND MAINTENANCE  
ORDINANCE**

WHEREAS, the Kendall County Historic Preservation Ordinance provides for the creation of the Kendall County Preservation Commission, an agency of the Kendall County Board invested with certain powers and duties pursuant to this Ordinance; and

WHEREAS, the Kendall County Board recommended adoption of the Historic Preservation Commission on August 15, 2006 as ordinance 06-67;

WHEREAS, all administrative procedures have been followed including a Public Hearing held before the Kendall County Historic Preservation Commission on August 18<sup>th</sup>, 2010;

NOW, THEREFORE, BE IT ORDAINED, the Kendall County Board hereby adopt the Historic Preservation guidelines for preservation, restoration, rehabilitation and maintenance as provided in attached Exhibit "A".

IN WITNESS OF, this Ordinance has been enacted by the Kendall County Board this 21<sup>st</sup> day of September, 2010.

Attest:

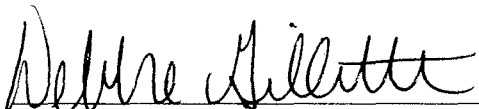
  
\_\_\_\_\_  
Kendall County Clerk  
Debbie Gillette

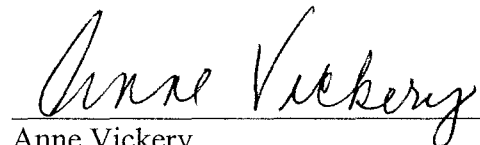
  
\_\_\_\_\_  
Anne Vickery  
Kendall County Board Chairman

**Kendall  
County  
Historic  
Preservation**

EXHIBIT A

*Guidelines for preservation, restoration,  
rehabilitation and maintenance*

Adopted by the Kendall County Historic Preservation Commission  
08/18/10

Adopted by the Kendall County Board  
09/21/10

## Introduction to the Guidelines

Kendall County's rich heritage of historical structures, sites, places, and districts deserve protection and careful management because they contribute greatly to the County's special character and identity. Therefore, a Certificate of Appropriateness (COA) is required, in addition to any required building permits, for exterior changes to designated Landmarks and properties located within Historic Districts. This manual is intended to inform owners, contractors and their agents of the basic standards required for compliance. The Kendall County Historic Preservation Commission (KCHPC) reviews proposed exterior changes and issues a COA when plans conform to standards in the Design Guidelines.

Landmark or Historic District designation does not change the use or zoning of the property nor does it require that the property owner restore or make improvements. It may provide the owner with the eligibility to apply for Federal income tax credits and grants when work is done that meets the Secretary of the Interior's Standards for Rehabilitation (See Appendix A). All existing zoning and building codes of the county shall be fully adhered to.

Common terms used in this manual are shall, shall not, should and should not. The use of the terms *shall* and *shall not* signify that property owners are required to follow the guideline as written. The use of the terms *should* or *should not* signifies that it is most appropriate for property owners to follow the meaning and intent of a guideline as written, however the Commission will be more flexible on these items. These terms also provide guidance as to how the Commission will generally approve or disapprove a Certificate of Appropriateness (COA) application.

The Guidelines are intended to regulate the exterior of the structure only, interior alterations that do not affect the appearance, features or materials of the exterior are not governed except by applicable building and zoning codes. The Guidelines are first concerned with the primary facades of buildings. A primary facade as defined in these Guidelines refers to all street facing facades and front facades, including those that face a side lot line. The fronts and visible sides of a building usually contain its most defining features such as porches, main entrances, and decorative details. The street or sidewalk is also where the public most often views a building.

Work to the rear of a building is usually reviewed with more flexibility since it is generally not visible due to the building's placement on the lot or screening by landscape or fences. The rear of a building is the most appropriate location for the construction of additional living space or other major alterations. Buildings on corner lots are the exception. Because the rear of a building on a corner lot is visible from the street, it will be reviewed with the same provisions for the sides of buildings.

The Guidelines apply to designated Landmarks and all properties within designated Historic Districts regardless of age or architectural style. For non-historic structures (properties that are less than fifty years of age or those that have been substantially altered), the Commission may apply the Guidelines with more flexibility. In reviewing work affecting non-historic buildings,

the Commission's approach is to maintain or enhance the building's relationship and compatibility with adjacent historic buildings and streetscapes.

The Guidelines emphasize preservation of existing building details, materials and overall plan rather than complete remodeling. Thus terms such as *repair*, *retain*, *maintain* are widely used throughout the Guidelines. To repair, retain and maintain architectural features and materials is preferred to their replacement.

Property owners are encouraged to refer to the Guidelines when planning new construction projects, exterior rehabilitation, and when performing everyday maintenance. The Guidelines include illustrated information on common rehabilitation questions, recommendations for maintaining the site and setting of the neighborhood and guidance for new construction. More information on all these subjects is available from the Historic Preservation Commission. The Appendix at the end of this manual lists other reliable sources of information.

To protect the overall character of the districts is the goal of the preservation ordinance and the Guideline document.

Nothing contained herein shall be construed as applying to uses or structures in agriculture districts and all existing zoning and building codes of the county shall be fully adhered to.

*The Kendall County Historic Preservation Commission is granted the authority to make reasonable rules and interpretations of the Guidelines to accomplish the Guideline goals.*

## Table of Contents

Introduction		2
Section I	Rehabilitation and Restoration Guidelines for	
	Existing Structures	7
	Antennas	28
	Architectural Details and Features	8-9
	Awnings	10
	Carriage House	15
	Chimneys	11
	Columns	24
	Doors	12-13, 29
	Dormers	42
	Downspouts	16
	Fascia	32
	Foundations	14
	Garages	15
	Gutters	16
	Lighting	17
	Masonry	18
	Outbuildings	15
	Painting	20-22
	Porches, Porticos and components	23-26
	Roofs	27
	Satellite Dishes	28
	Shutters	31
	Siding	36-37
	Skylights	27
	Soffit	32
	Solar Panels	28
	Stairs	26
	Stucco	18
	Substitute Materials - <i>See Preservation Brief 16</i>	
	Tuck pointing	18
	Windows	30, 33-35
Section II	New Construction Guidelines	38
	Additions	39, 42
	Buildings	43
	Decks	40
	Dormers	42
	Garages	41
	Outbuildings	41
	Sheds	41
Section III	Site and Setting Guidelines	44
	Air Conditioners	49

	Driveways	50
	Dumpsters	49
	Fences	45-46
	Fountains	53
	Fire escapes	47
	Gazebos	53
	Landscaping	48
	Mechanicals	49
	Parking	50
	Pergolas	53
	Ramps, accessibility	51
	Secondary exits	47
	Sidewalks and walkways	52
	Signage	54
	Swimming pools	53
	Walls	45
Section IV	Agricultural Structures and Farmsteads	55
Section V	Commercial Centers & Storefronts <i>(Under Construction)</i>	57
Section VI	Signage <i>(Under Construction)</i>	56
Section VII	Demolition and Removal <i>(Under Construction)</i>	59
Appendices:	Secretary of the Interior's Standards <i>(Not yet added)</i>	54
 Preservation Briefs <i>(Not yet added)</i>		
	01: Assessing Cleaning and Water-Repellent Treatments for Historic Masonry Buildings	
	02: Repointing Mortar Joints in Historic Masonry Buildings	
	03: Conserving Energy in Historic Buildings	
	04: Roofing for Historic Buildings	
	05: The Preservation of Historic Adobe Buildings	
	06: Dangers of Abrasive Cleaning to Historic Buildings	
	07: The Preservation of Historic Glazed Architectural Terra-Cotta	
	08: Aluminum and Vinyl Siding on Historic Buildings: The Appropriateness of Substitute Materials for Resurfacing Historic Wood Frame Buildings	
	09: The Repair of Historic Wooden Windows	
	10: Exterior Paint Problems on Historic Woodwork	
	11: Rehabilitating Historic Storefronts	
	12: The Preservation of Historic Pigmented Structural Glass (Vitrolite and Carrara Glass)	
	13: The Repair and Thermal Upgrading of Historic Steel Windows	
	14: New Exterior Additions to Historic Buildings: Preservation Concerns	
	15: Preservation of Historic Concrete	
	16: The Use of Substitute Materials on Historic Building Exteriors	

- 17: Architectural Character - Identifying the Visual Aspects of Historic Buildings as an Aid to Preserving Their Character
- 18: Rehabilitating Interiors in Historic Buildings - Identifying Character-Defining Elements
- 19: The Repair and Replacement of Historic Wooden Shingle Roofs
- 20: The Preservation of Historic Barns
- 21: Repairing Historic Flat Plaster - Walls and Ceilings
- 22: The Preservation and Repair of Historic Stucco
- 23: Preserving Historic Ornamental Plaster
- 24: Heating, Ventilating, and Cooling Historic Buildings: Problems and Recommended Approaches
- 25: The Preservation of Historic Signs
- 26: The Preservation and Repair of Historic Log Buildings
- 27: The Maintenance and Repair of Architectural Cast Iron
- 28: Painting Historic Interiors
- 29: The Repair, Replacement, and Maintenance of Historic Slate Roofs
- 30: The Preservation and Repair of Historic Clay Tile Roofs
- 31: Mothballing Historic Buildings
- 32: Making Historic Properties Accessible
- 33: The Preservation and Repair of Historic Stained and Leaded Glass
- 34: Applied Decoration for Historic Interiors: Preserving Historic Composition Ornament
- 35: Understanding Old Buildings: The Process of Architectural Investigation
- 36: Protecting Cultural Landscapes: Planning, Treatment and Management of Historic Landscapes
- 37: Appropriate Methods of Reducing Lead-Paint Hazards in Historic Housing
- 38: Removing Graffiti from Historic Masonry
- 39: Holding the Line: Controlling Unwanted Moisture in Historic Buildings
- 40: Preserving Historic Ceramic Tile Floors
- 41: The Seismic Retrofit of Historic Buildings: Keeping Preservation in the Forefront
- 42: The Maintenance, Repair and Replacement of Historic Cast Stone
- 43: The Preparation and Use of Historic Structure Reports
- 44: The Use of Awnings on Historic Buildings: Repair, Replacement and New Design
- 45: Preserving Historic Wooden Porches
- 46: The Preservation and Reuse of Historic Gas Stations
- 47: Maintaining the Exterior of Small and Medium Size Historic Buildings

## **Section I: Rehabilitation and Restoration to Existing Buildings**

The following Guidelines are designed to both encourage and promote the sensitive restoration, renovation, and preservation of individual Historic Landmarks and properties located within Kendall County's Historic Districts. This section of the Guidelines addresses rehabilitation and restoration work to existing buildings. Sections that address New Construction, Site and Setting, Agricultural Structures and Farmsteads, Commercial Centers and Storefronts, Signage, and Demolition and Moving Procedures follow.



**Architectural Details and Features**

- A. Architectural details and features shall not be removed or altered if original to the building.
- B. Architectural details and features should be repaired rather than replaced.
- C. Architectural details and features shall not be covered or concealed with vinyl, aluminum or other artificial material.
- D. Architectural details and features should not be added unless there is physical, or historical evidence that such features were original to the building. These features should match the original in materials, scale, location, proportions, form, and profiles.
- E. Architectural details and features if deteriorated beyond repair, should be replaced. The new materials should match the original as closely as possible.

*Architectural details and features include but are not limited to such character defining features as gingerbread, verge boards, eaves, brackets, dentils, friezes, cornices, soffits and fascias, moldings, hood molds, trim, columns, pilasters, balusters, clapboard, shingle and stucco surfaces, rafter tails, spindles, ornament, quoins, or any decorative element. Buildings display a wide variety of architectural features and detailing. These are essential in defining a property's architectural style and period of construction. Original architectural details and features need to be preserved and maintained.*

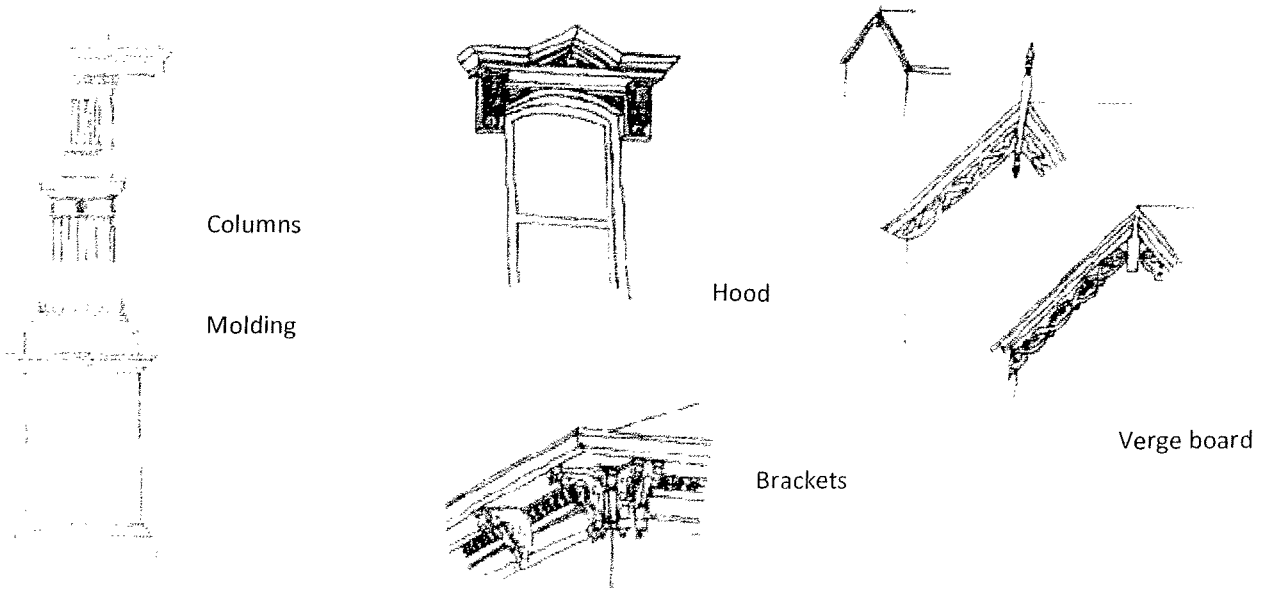

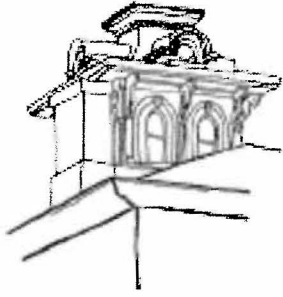

Italianate Cupola

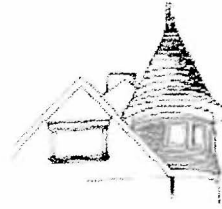

Queen Anne turret

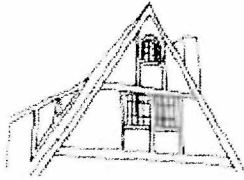

Tudor Revival timbering

**New, Repaired or Replaced Awnings**

- A. Awnings shall be of canvas, or similar woven material, and compatible with the style of the house. Metal, fiberglass, or vinyl awnings shall not be used.
- B. Awnings should not cover or conceal significant architectural details such as window hood molding.
- C. Awnings should be of colors to compliment the dwelling.
- D. Awnings should fit the opening to which they are applied. Rectangular openings should have straight across shed type awnings, not bubble or curved forms. Arched openings should have curved or rounded, not bubble, awnings to match the opening.
- E. Awnings should be attached with care to prevent unnecessary damage of original details and materials.
- F. Awnings with illumination shall not be used.
- G. Awnings should not be used at windows with shutters.

*Canvas awnings were applied to windows, doors, and porches to provide shade during the summer. Awnings fell out of favor following the introduction of air conditioning. The application of canvas awnings is appropriate for historic dwellings, but may not be appropriate for all locations. Examples of poor awning locations include decorative windows such as oriels, fanlights, and those with prominent decorative glazing.*

*Modern awnings, often made from metal, fiberglass, or vinyl bear little resemblance to historic canvas awnings and are not appropriate.*

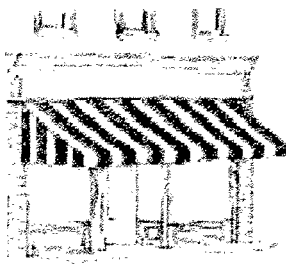

Awnings should reinforce openings, not cover features

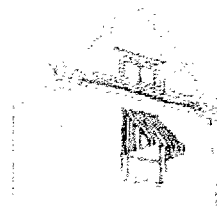

Awnings should fit the opening to which they are applied

Chimneys

- A. Chimneys shall not be removed or altered if original.
- B. Chimneys shall be cleaned and re-pointed in accordance with Masonry Guidelines below.
- C. Chimneys which require rebuilding shall be rebuilt to match the original design in materials, colors, shape, mortar profile, and masonry pattern.
- D. Chimneys should have clay, slate, or stone caps. Concrete and metal caps may be acceptable for some styles if they are not readily visible.
- E. Chimneys should not be covered with stucco or other non-original materials.
- F. Original decorative chimney pots should not be removed.
- G. Chimneys that have been extensively re-pointed resulting in mismatched colors and textures may be painted in brick colors such as dark red or brown.

*Chimneys often feature decorative masonry work or designs that are part of a dwelling's architectural character. Many exterior wall chimneys are essential features to a dwelling's overall design. These are typically found in Queen Anne or Tudor Revival styles. Some less decorative chimneys have simple details such as banding or corbeling. Chimneys need to be maintained and preserved in accordance with the masonry Guidelines*

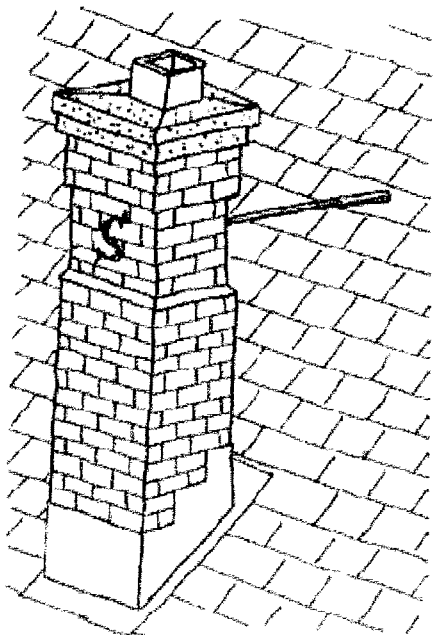

Corbelled chimney with metal tie rod and stone cap

Also see:

- 1) *Preservation Briefs No. 1 - Assessing Cleaning and Water-Repellant Treatments for Historic Masonry*
- 2) *Preservation Briefs No. 2: Repointing Mortar Joints in Historic Masonry Buildings*

### **Doors**

A. Doors and/or original door features such as surrounds, sidelights, and transoms shall not be removed or altered. Door openings shall not be enlarged, reduced, or shortened for new door installation.

B. Doorways that need to be altered to meet accessibility codes should adhere to the Historic Preservation provisions of the accessibility codes where you are able.

C. Doors that are missing or deteriorated beyond repair on the front or side facades visible from the street shall be replaced with doors appropriate for the style and period of the building. Replacement doors shall be similar in design to the original in style, materials, glazing (glass configuration) or appropriate to the architectural style of the building.

D. Unless they are historic to the building, doors of flush wood or steel design shall be used only at rear entrances or side entrances that are not visible from the street.

E. Doors shall not be added at locations where they did not originally exist, unless needed to meet safety codes. When necessary, doors should be added at the rear or sides of dwellings where they will not be visible.

*Doors and door surrounds are significant in defining the style and character of a dwelling. Original doors, door surrounds, and hardware need to be preserved and maintained.*

*Doors readily available from most wholesale hardware stores generally reflect designs for houses built after 1940 and may not be appropriate. Door construction and style varies widely from one architectural style to another. What is appropriate for one historic house may not be appropriate for another.*



Appropriate for Greek Revival and Octagon styles

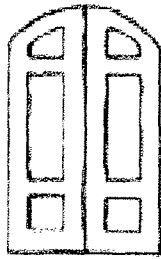

Appropriate for Italianate, Second Empire, Gothic Revival styles



Appropriate for Gothic Revival styles

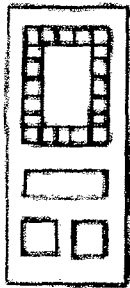

Appropriate for Stick, Queen Anne, Eastlake, Shingle styles



Appropriate for Colonial Revival, Neo-classical styles

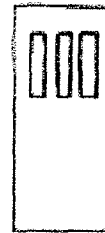

Appropriate for Craftsman, Bungalow styles



Appropriate for Tudor Revival style



Appropriate for Modern style

Foundations

A. Foundations should be retained and not altered.

B. Foundation alterations, if required, should not be made at visible facades.

C. Foundations shall be cleaned, repaired, or re-pointed according to masonry guidelines.

D. Foundations shall not be concealed with concrete block, plywood panels, corrugated metal, or other non-original materials.

E. Foundations of brick may be painted or covered with cement coating to match the original building material if the brick and/or mortar is mismatched or inappropriately repaired.

F. Stuccoing as a method of foundation repair should not be used.

Most early historic dwellings have stone, brick or concrete foundations. Repointing and repair shall follow Masonry Guidelines.

*Also see:*

*1) Preservation Briefs No. 1 - Assessing Cleaning and Water-Repellant Treatments for Historic Masonry*

*2) Preservation Briefs No. 2: Repointing Mortar Joints in Historic Masonry Buildings*

Existing Garages, Carriage Houses and Outbuildings

A. Garages, carriage houses or outbuildings that contribute to a property's historic character, or are original to a property shall be preserved and maintained. Original features should be repaired to match the original.

B. Garages, carriage houses or outbuildings original to a property should not be moved or relocated to another part of the lot.

C. Original doors should be maintained, but may be retrofitted with modern hardware and custom garage door openers.

D. Doors deteriorated beyond repair may be replaced with new doors. These should match original doors with features such as raised panels and glass window sections. Many styles appropriate for historic buildings are available with overhead opening, but the look of original swing doors. Avoid solid metal or fiberglass doors.

E. For architectural features visible from the street on garages, carriage houses, and outbuildings, refer to appropriate sections of this guide.

Some historic properties contain outbuildings including servant's quarters, sheds, carriage houses, and automobile garages. These were often built with construction techniques and materials to match the primary dwelling. Although some are not original, many have architectural significance. These buildings should be preserved and maintained.

NOTE: For new garages see New Construction Guidelines.

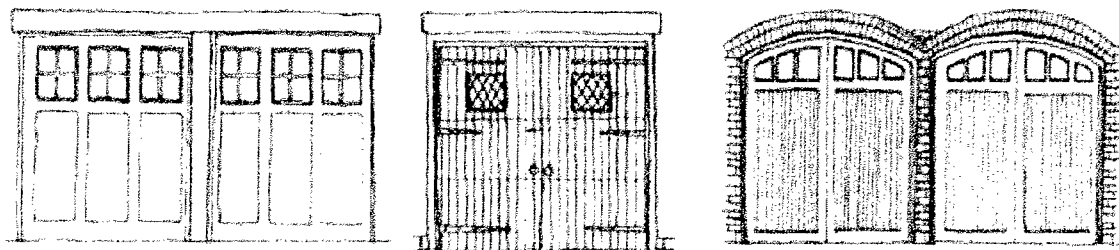

Appropriate garage doors for historic properties



### Gutters and Downspouts

- A. Gutter and downspout installation shall not result in the removal of any existing eave features.
- B. Gutters and downspouts of boxed, built-in type, and/or copper should be preserved, and repaired rather than replaced if possible.
- C. Gutters and downspouts of early hang-on type should be half-round rather than “K” or ogee. If the gutters are not readily visible, ogee gutters of aluminum or vinyl are acceptable.
- D. Gutters and downspouts should be located away from significant architectural features on the front of the building.
- E. Gutters and downspouts should be designed and installed to provide proper drainage and to channel the water as far away from the dwelling as possible. Downspouts should extend at least 4 to 6 feet, or utilize a splash block. Round downspouts are more appropriate than rectangular forms, for half round gutters. Rectangular downspouts are also acceptable.
- F. Hanger straps should be nailed under, not on top, of the roofing material. If new roof is installed at same time as the gutters, the straps shall be nailed under the roofing material.
- G. Gutters shall match the color scheme of the house. Copper gutters may remain unpainted.

Gutters and downspouts should be regularly cleaned and maintained. If new gutters are required, half-round designs are the most historically accurate for the earlier styles.

Some later styles; the Romanesque, Colonial, Italian Renaissance, Tudor Revival Styles, and Neoclassical, all typically with enclosed eaves, used the ogee (K profile) gutter. Some styles or designs feature rectangular or bevel profiles or hidden built-in type gutters. Metal used for gutters and downspouts should be compatible with metal used for roof flashing to avoid corrosion.

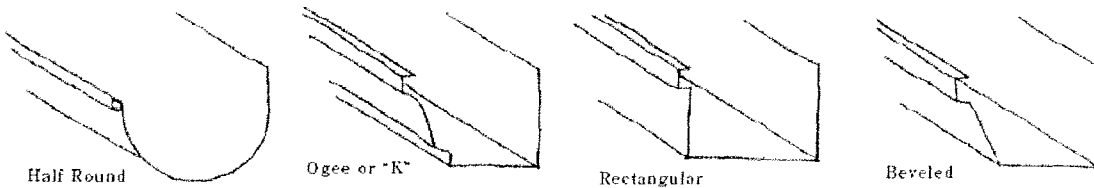

**Lighting (For Porches and Exterior Walls)**

A. Lighting fixtures original to the dwelling should be preserved and maintained.

B. New lighting fixtures shall be compatible with the style, scale, and period of the structure, based on traditional designs of the late 19th and early 20th centuries, and mounted on porch ceilings or adjacent to entrances.

C. Building mounted security lighting should be only for security. Flood lights should be mounted on the rear or sides of a building not visible from the street. High intensity overhead lights should not be used.

D. Light fixtures for security lights, flood lights, or foot lights should be small, simple in design, and their number kept to a minimum.

E. If freestanding fixtures are installed, they shall also be compatible with the character of the building style, and shall not conflict with any period streetlights.



F. Buildings that originally did not have lights mounted on the exterior walls or porch ceilings may need lighting. New fixtures should be simple in design and not detract from the building style. Electrified versions of early gas light fixtures may be appropriate.

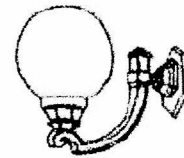

G. Unobtrusive site lighting can be used to provide adequate illumination without calling attention to the light source.

H. Awnings with illumination shall not be used.

*Appropriate simple fixtures for early styles that were not originally electrified*

Some historic buildings retain original exterior wall and porch ceiling light fixtures. These are part of a building's character and should be preserved and maintained. If the original light fixtures are missing, use light fixtures appropriate to the building's style. When appropriate fixtures are not available, simple designs and detailing are preferred to large, ornate ones.



Colonial Revival Style



Tudor Revival, Bungalow Style



Prairie, Bungalow Style



Colonial Revival, Neo-classical Style



Modern Style

## Masonry and Stucco

- A. Masonry original to the dwelling shall be preserved and maintained.
- B. Masonry shall not be sandblasted or abrasively cleaned. Brick should not be cleaned with high-pressure water that exceeds 300 pounds per square inch.
- C. Masonry should be cleaned only if there are major stains or paint buildup. If the staining or dirt is limited, it may be best left alone. Masonry should be cleaned by the gentlest effective method. Use detergent cleaners and natural brushes for staining, do not use metal brushes. The use of chemical cleaners is appropriate using low-pressure water to avoid forcing water and chemicals into the wall. This usually requires professionals. Information on the use of chemical paint removal and cleaning products is available from the Preservation Division.
- D. Masonry should not be coated with silicone-based water sealants. Water sealants or water repellents should be highly vapor permeable. Impermeable coatings trap interior moisture damaging the brick.
- E. Masonry that has not been previously painted shall not be painted unless the brick and mortar is extremely mismatched from earlier repairs or patching. Previously sandblasted brick or brick in poor condition may be painted to provide a sealing coat. These paints must be vapor permeable.
- F. Masonry shall not be covered in stucco, artificial stone, brick veneer, shingles, or other coating materials, except for foundations that may be coated with a cement coating if deteriorated. Refer to Foundations.
- G. Masonry repairs should be performed carefully to match the original stone or brickwork and mortar. If new stone or brick is required, match brick color, texture, and size. Match stone for type size and finish.
- H. Re-pointing (tuck pointing) mortar shall match the original in width, color, tooling profile, composition, and texture. Remove mortar using methods that will not cause damage to the stone or brick. Re-pointing should never be done with hard mortars unless these mortar compounds are original to the dwelling. If the original composition cannot be determined, use a historic compound such as one part lime, one part Portland cement, and six parts sand. Use natural sand.
- I. Stucco surfaces shall be maintained by cleaning and repainting with appropriate masonry paint when necessary. When repairing original stucco, a stucco mixture duplicating the appearance shall be used. Patches of incompatible composition will adhere poorly and will fail.
- J. When attaching approved elements to masonry, anchoring devices shall be drilled into mortar joints and not into the brick or stone.

Many historic dwellings have exterior walls of masonry. Masonry includes brick, stone, and terra cotta. If well maintained, these can last indefinitely.

Important points in masonry preservation are to keep out water and to use an appropriate mortar mix when repair is needed. The use of hard mortars high in Portland cement can cause early brick to crack and break. Portland cement was used after 1920 and generally this type of hard mortar is compatible only with brick from after 1920.

Abrasive cleaning methods such as sandblasting or water blasting erodes the outer skin of the brick and destroys the surface crust allowing moisture to enter the wall. Low pressure cleaning is best for cleaning masonry. Sandblasting is not appropriate because it damages the hard protective surface layer of brick and mortar joint profiles

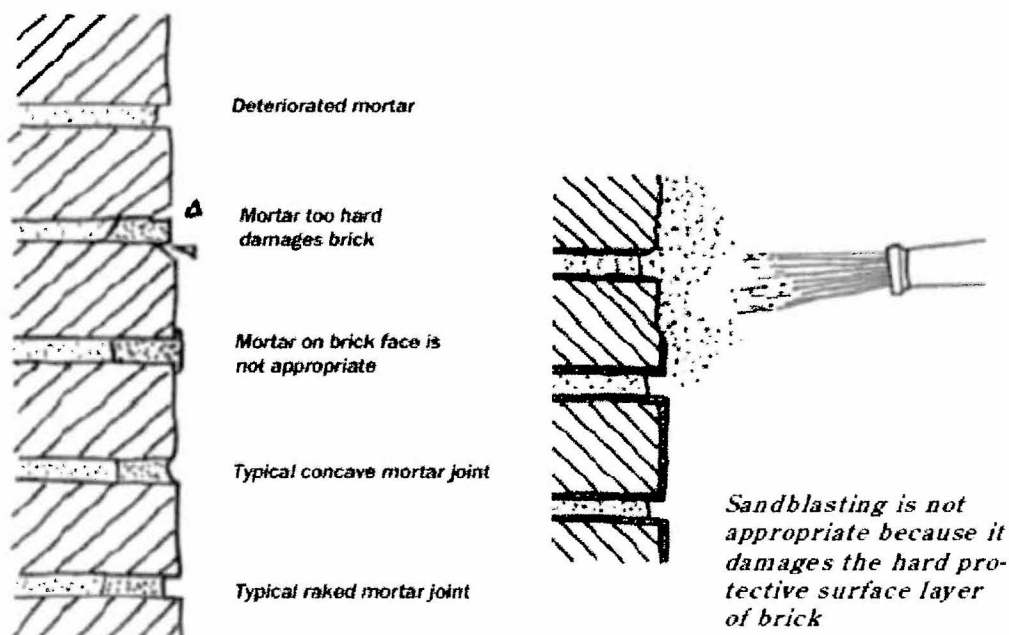

See also, *Preservation Briefs*:

*No. 1 - Assessing Cleaning and Water-Repellant Treatments for Historic Masonry and,*

*No. 2: Repointing Mortar Joints in Historic Masonry Buildings*

*No 22: The Preservation and Repair of Historic Stucco*

*No 42: The Maintenance, Repair and Replacement of Historic Cast Stone*

**Surface Preparation for Painting**

A. Removal of existing paint should be done by manual scraping or with appropriate chemical removers.

B. Removing paint through heat plates or heat guns should be done using caution to avoid unnecessary damage to the wood through charring or fire.

C. Abrasive sand blasting to remove paint shall not be used. Water blasting above 600 pounds per square inch to remove loose paint is not recommended as it can cause damage.

D. Surface preparation should include identification and appropriate handling of lead based paints to avoid hazards.

E. The existing surface including any soundly adhered paint should be compatible with the new paint. Paints should be applied according to manufacturers' instructions.

Many exterior wood elements require a coating to protect them from deterioration. It is important to keep maintaining painted surfaces so those key features can be preserved.

The use of blowtorches to remove paint may lead to a fire hazard. Also, the use of abrasive sand will damage the wood siding and raise the grain. In addition, during this process, water forced into the wood can take a long time to dry. Paint will not adhere to wet or damp wood, and the wood may develop mildew or rot.

*See also Preservation Brief 6: Dangers of Abrasive Cleaning to Historic Buildings and Preservation Brief 10: Exterior Paint Problems on Historic Woodwork*

## Paint and Paint Colors

The selection of paint colors does not require approval by the Commission. The Historic Preservation Commission is available to provide recommendations for paint colors if requested. Paint charts with historic colors are also available at most paint stores.

Consider painting the dwelling in keeping with its style and period of construction. Avoid bright hues and too many colors on a building. Select architectural details of the dwelling to highlight. Painting with high quality exterior paints will last from eight to fifteen years. Sunlight exposure, regular gutter and downspout maintenance and wood surface condition and preparation affect paint life.

A. Paint colors do not require review and approval however; books and paint charts are available to select appropriate colors. Because color has a predominant effect on the character of a district, it is recommended that residents consult the Kendall County Historic Preservation Commission for assistance in selecting paint colors and schemes before painting any building covered by these Guidelines.

B. Paint should be of high quality applied to properly prepared surfaces to provide a long lasting finish.

C. In most instances, paint should not be applied to unpainted masonry. (For exceptions, see Masonry Section D.)

D. All exterior wood surfaces, new and old, shall be painted or stained except for wood shingles that may or may not be painted. (See Shingle Style) All painting shall be completed within twelve months according to manufacturer's recommendations, weather permitting.

E. Paint colors and placement should be appropriate for the dwelling's architectural style and design. The TABLE on page 22 lists some suggested colors.

### ***See Preservation Briefs:***

No. 6: Dangers of Abrasive Cleaning to Historic Buildings and,

No. 10: Exterior Paint Problems on Historic Woodwork and,

No. 28: Painting Historic Interiors and,

No. 37: Appropriate Methods for Reducing Lead-Paint Hazards in Historic Housing

**TABLE 1: Paint colors for historic homes**

Style		Body	Trim & Accents
Italianate Style	Light colors for the body and trim	Tan, Light Brown, Beige, Light Green, Yellow	Cream, Gray, Light Brown
Queen Anne & Second Empire	Diversity of colors using combinations of contrasting colors for the body and trim	Tan, Red, Green, Brown	Darker colors such as Dark Olive, Salmon Red, Dark Brown
Shingle	Most shingle style dwellings were originally built with the exterior wood shingles stained or left natural rather than painted. Most of these dwellings have been painted over the years and a return to the dark browns and reds of the wood shingles is recommended	Dark Red, Brown, Dark Gray, Dark Green	Dark Green, Dark Brown
Prairie & Four Square	A return to lighter colors such as yellow and off white. For Four Square - Two color paint scheme, one for lower level and the other for the upper level. Also: earlier versions had Victorian colors, later versions had Colonial Revival colors.	Light Tan, Light Yellow, Light Brown, Grays, Medium to Light Greens	Off-whites, Cream, Brown, Blues, Greens
Bungalow & Tudor Revival	Darker colors again such as earth tones. Dark stains also used in place of paint. Brick, stone, stucco, and concrete generally left unpainted.	Brown, Green, Gray, Dark Red	Both light and dark trim colors such as Reds, Browns, Greens, and shades of Tan.
Colonial Revival	Light colors predominate	Yellow, Light Gray, Light Blue, White	White, Off-white, Cream

## **Porches, Porticos and Components**

Porches are defining characteristics of historic buildings. If replacement of porch features is required, use materials that closely match the original. If the original porch is missing, a new porch should be constructed based upon photographic or physical evidence of the original. If such evidence does not exist, the design should be based on historic porches of similar buildings from the same time period and architectural style.

Inappropriate porch additions may be removed and more appropriate porches, based on historic precedent may be constructed.

A vernacular house may have an Italianate or Queen Anne porch. These are acceptable and reflect changes over time.

Handrail height and style should be determined by photographs, paint outlines, paint shadows, and/or similar homes in the area.

- A. Porches on front and side facades that are original or important to a building's historical integrity shall be maintained in their original design and with original materials and detailing unless they are deteriorated beyond repair.
- B. Porches original or important to the building's historical integrity that have deteriorated or have deteriorated components shall be repaired or replaced to match the original in design, materials, scale, dimensioning, detailing, and placement.
- C. Porches with wood components shall be painted unless the building style features unpainted wood such as found in the Shingle or Modern style. See Paint Section.
- D. Porches on the front façades shall not be enclosed with wood, glass, or other materials that alter the open appearance. If historically the porch style was enclosed, windows, doors and screening of style and material appropriate to the building style may be used.
- E. Porches may be screened. If screened, the structural framework for the screen panels shall be minimal and the open appearance of the porch maintained. Screen panels shall be placed behind the original features such as columns or railings and shall not hide decorative details or result in the removal of original porch materials.
- F. Porches with wood porch floors should have wood steps. The treads shall have rounded nosings. Wood floors should have wood tongue and groove flooring running perpendicular to the facade
- G. Original porches of masonry or patios and terraces with poured concrete floors may have poured concrete steps.



H. Porches with open areas below should be enclosed as was traditional for the type and style of the original porch building material. This could include decorative wood framed skirting, vertical slats, or lattice panels.

I. All new components of a porch shall be painted within twelve months, weather permitting.

J. Porch columns and railings shall be preserved and maintained. When repair is required, use materials to match the original in dimension and detailing. Epoxy consolidants can be used.

K. Porches may have wood trellises added if they will not result in the removal of original porch building material.

L. Porch columns and railings of aluminum, wrought iron, or other modern materials, with the exception of some houses built after World War II, are not appropriate.

M. Porch columns and railings, if the originals have been removed or replaced, on front porches and porches visible from the street shall/should be rebuilt in historic designs to match the style of the building.

N. Porches may require new balusters for the railing. Porch balusters (also called spindles) shall be appropriate for the building's style and period. They shall be located between a top and bottom rail.

*Also see Preservation Brief 45: Preserving Historic Wooden Porches*

### Porches, Porch Components, and Porticos

#### Parts of a porch:

1. Column
2. Handrail
3. Baluster
4. Newel post
5. Lattice skirting

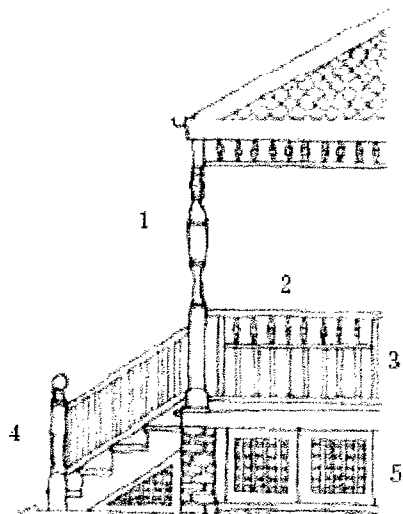

Eastlake Style Porch

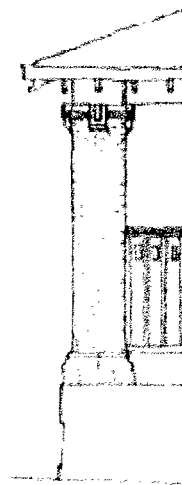

Prairie Style Porch

Appropriate Columns  
for Various Styles

- 1) Greek Revival
- 2) Italianate, 2<sup>nd</sup> Empire
- 3 & 4) Gothic Revival
- 5 & 6) Queen Anne,  
Eastlake, Stick
- 7) Colonial Revival, Neo-  
classical

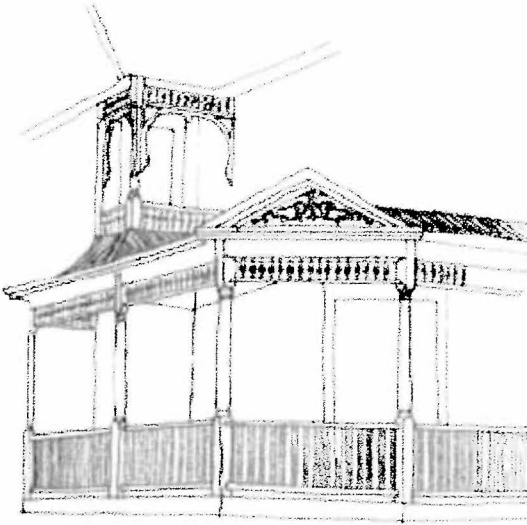
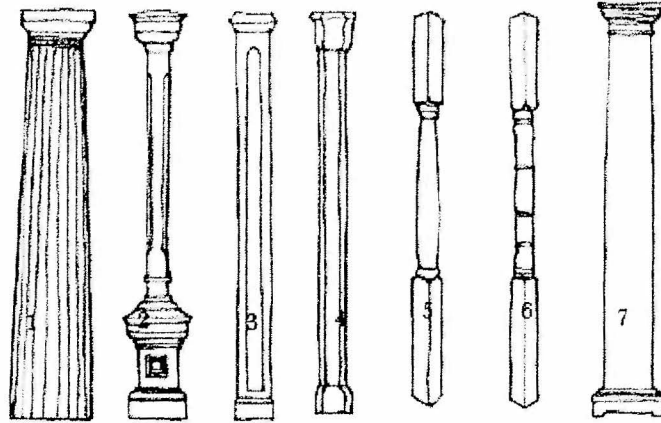

Well maintained porch, Queen Anne style



Appropriate enclosure of front porch,  
Bungalow or Craftsman style

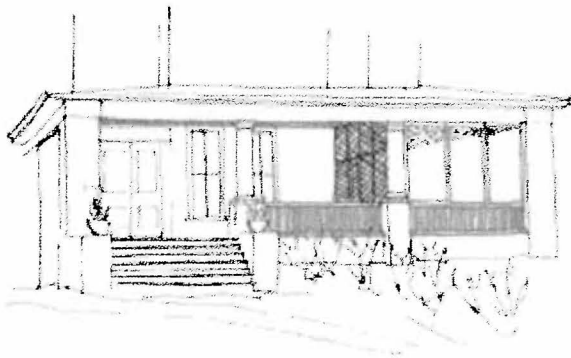

Appropriate porch screening - screens do not  
obstruct architectural features

Appropriate stair construction

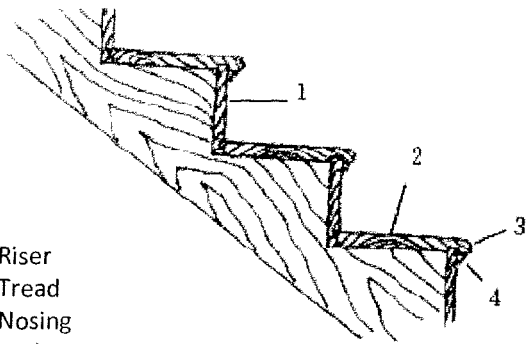

- 1. Riser
- 2. Tread
- 3. Nosing
- 4. Molding

Inappropriate stair construction

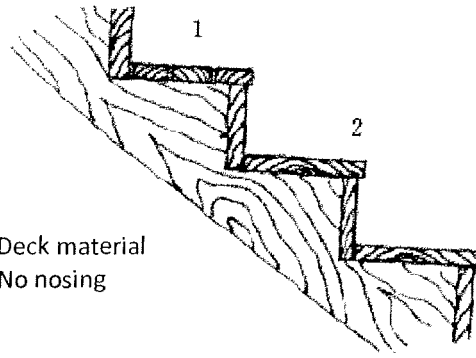

- 1. Deck material
- 2. No nosing

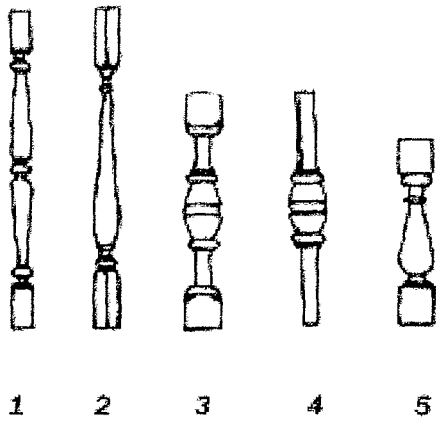

Appropriate balusters

- 1, 2, 3 Queen Anne, Eastlake, Stick
- 4, 5 Italianate, 2<sup>nd</sup> Empire, Neo-classical

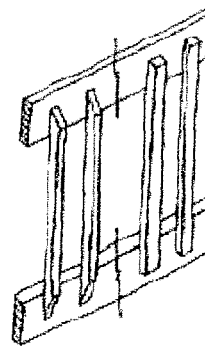

Inappropriate railing construction

- 1 Balusters not between top and bottom rails
- 2 Handrail is not beveled

## **Roofs and Roof Elements**

The original roof form and materials are a major component of a building's architectural style. It is important that these be retained.

Additions that will affect roof forms should be placed so as to minimize their impact as viewed from the street. See Roofline Additions.

Historic roofs of materials such as metal shingles, clay tiles, or slate should be repaired and preserved whenever possible. Sawn cedar shingles were commonly used on older buildings. Split cedar shakes are inappropriate in most cases.

A. Roofs and roof elements shall be retained in their original shape and pitch, with original features including cresting, chimneys, vents, finials, cupolas, etc. and, if possible, with original roof materials.

B. For new dormers, roof decks, balconies or other additions see Roofline Additions.

C. Roofs may be re-roofed with substitute materials such as asphalt or fiberglass shingles if the original materials are determined beyond repair, are no longer present or available, or if the retention of the original roof material is not economically feasible. Particular effort shall be made to retain materials such as slate, tile, and other unique materials not commonly found in new construction.

D. Roofs of new asphalt or fiberglass shingles shall be one color and shall be compatible with historic colors and the style or period of the house. Asphalt shingle in dark shades of gray, red, brown or black are appropriate for the replacement of early asphalt shingles and as a substitute material for wood shingles. Dark gray or black asphalt shingles are an appropriate substitute for slate shingles, and red or green asphalt shingles are appropriate substitutes for clay tile roofing materials. New materials shall match as closely as possible to the original in composition, size, shape, color and texture.

E. Roofs that are flat and were originally metal should be replaced in metal. If not readily visible, other low pitch roofing materials are acceptable.

F. Roofs requiring ventilation should have ridge vents rather than pot vents. If pot vents are necessary they should be located at rear rooflines, or near the rear (as in a front facing gable house). These vents should be painted to match the roof color. Roof gable vents should be maintained.

G. Skylights original to the house should be preserved. Skylights shall not be added where they would be visible from the street. Skylights should be placed at rear rooflines or behind gables and dormers. Skylights should be flat or flush with the roofline, not convex or "bubble" designs.

See also Preservation Brief No. 4: Roofing for Historic Buildings

**Satellite Dishes, Antennas, and Solar Panels**

A. Satellite dishes, antennas, and solar panels shall not be installed in front yards or in side yards visible from the street. Dishes or solar panels should not be installed at visible rooflines.

B. Satellite dishes and antennas in the smaller sizes are more appropriate than the large dishes.

C. Satellite dishes, antennas, and solar panels should be mounted as low to the ground as possible and the use of landscaping, lattice panels, or fencing to screen the view is recommended.

D. If practical solar panels shall not be added where they would be visible from the street. Solar panels should be placed at rear rooflines or behind gables and dormers. Solar panels should be flat or flush with the roofline.

E. Satellite dishes and antennas should be located at rear rooflines or preferably in rear yards.

F. Antennas mounted on the roof shall not extend more than three feet higher than the closest roof within ten feet.

Satellite dishes may be installed if they are sited in rear yards or along side yards that are not visible from the street. As non-historic features, the smaller dishes are preferred to the larger dishes.

New innovations in solar power may be allowed upon the review and approval of the Kendall County Historic Preservation Commission.

**Screen, Storm, and Security Doors**

Security doors are non-historic additions to dwellings. While the installation of security doors on fronts of buildings is discouraged, they may be installed if they allow the viewing of most of the historic door. Ornate security doors with extensive grillwork or decorative detailing are not appropriate. However, certain decorative detailing may be appropriate for storm or screen doors for some styles such as Queen Anne.

A. Original wood frame storm or screen doors shall be maintained. Screen, storm, and security doors shall be correctly sized to fit the entrance opening and shall be compatible with the style of the building. Door openings shall not be enlarged, reduced, or shortened for new door installation.

B. Security doors are less appropriate for fronts of dwellings than at rear and side facades not visible from the street. Security doors added to the fronts of dwellings shall be full view design or have minimal structural framework to allow for the viewing of the primary door behind them.

C. Security doors at locations not visible from the street are acceptable and may have more extensive structural framework than would be acceptable for doors visible from the street.

D. Screen and storm doors added to the front or visible side doors should be wood. These should be either full view or with divisions aligned to those of the primary door.

E. When metal screen, storm, or security doors on front or visible sides are used, they shall have a painted, anodized, or non-metallic finish to match the trim color.

**Screen Doors**



- *Appropriate: full view door*



- *Appropriate for Queen Anne, Eastlake and Stick styles*



- *Appropriate: glass aligns with door glass*



- *Not appropriate for historic doors*



- *Not appropriate: obscures door*



- *Not appropriate: glass does not align with door glass*

### **Screen, Storm, and Security Windows**

Screen, storm, and security windows are acceptable for historic dwellings. Their design and style should not obscure the primary windows.

Storm windows help reduce energy costs and reduce the occurrence of condensation on windows. Wood does not conduct the cold air to the inside as much as metal when used in storm windows.



Wood storm windows are not only attractive but they increase energy efficiency as well.

Both the primary window and the storm window should be properly weather-stripped to help keep out air infiltration and further reduce energy costs.

- A. Screens and storm windows shall be correctly sized to fit the window openings including round arched windows. Frames should not obscure the glass area of windows. Screen and storm window panels shall be full view design or have the meeting rail match that of the window behind it.
- B. Screens and storm windows shall be wood or aluminum with a painted, baked-on, or anodized finish. Windows of raw aluminum are not acceptable unless painted to match the color of the window sashes.
- C. Storm windows with built-in lower screens are acceptable.
- D. Window security bars may be applied on windows that are not visible from the street.
- E. Basement windows may be secured on the inside with a plywood board or with bars painted black provided it is in accordance with the Kendall County building codes.
- F. For screens and storm windows for porches, see Porches and Porch Elements.

## Shutters

Window shutters were often added to houses to provide interior shading in the summer and to protect windows during storms.

A. Window shutters original to the dwelling should be preserved and maintained.

B. Window shutters shall not be added unless there is physical or photographic evidence that the dwelling originally had them, or if they are compatible with the style of the house.

C. Window shutters shall be of louvered or paneled wood construction and the shutters sized to fit the window opening so that, if closed, the shutters would cover the entire window opening.

D. Exceptions to C. for the following styles: Colonial Revival, Mission, Tudor Revival, and Modern, may be made upon review and approval of the Historic Preservation Commission.

E. Window shutters of vinyl or aluminum construction are not appropriate. These shutters generally have dimensions that are not compatible with historic dwellings.

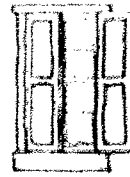

▪ *Appropriate*

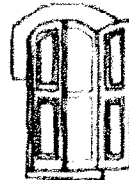

▪ *Appropriate*

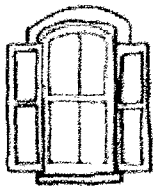

*Does not fit arch*

- *Not Appropriate*

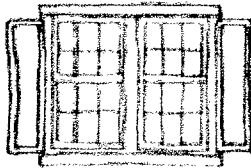

*Shutters do not fit opening*

- *Not Appropriate for most styles*
- *Appropriate only for Colonial Revival, Tudor Revival, and Mission styles*

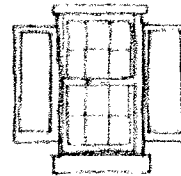

*Too short*

- *Not Appropriate*

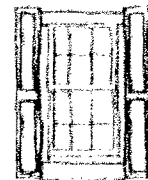

*Too long*



## Soffit and Fascia

The soffit is the flat horizontal board that encloses the space under the eave or cornice. Often bead board is used for historic homes.

The fascia is the flat board used to cover the ends of roof rafters or located along the rake. Cornice molding or trim is often placed on the fascia board.

A. Original soffit, fascia, trim boards and details shall not be removed. They shall be maintained by painting and proper gutter functioning.

B. Soffit, fascia boards, trim and details deteriorated beyond repair shall be replaced with boards that match the originals.

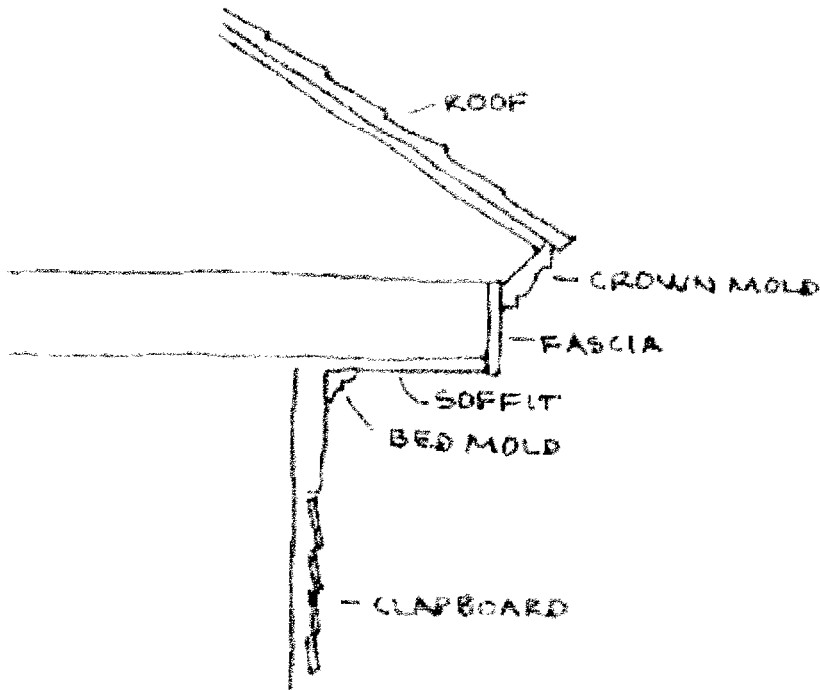

## **Windows**

- A. Windows shall be preserved in their original location, size, and design and with their original materials and glass pattern.
- B. Window openings on front facades or side facades visible from the street shall not be altered to accommodate new windows of different size, proportion or configuration.
- C. Character defining window openings on all facades shall not be altered.
- D. New window openings shall not be added to front facades or to side facades where visible.
- E. Windows should be repaired rather than replaced. If non-original or beyond repair and replacement is necessary, the replacement shall be in-kind to match the original in material and design.
- F. Windows should be repaired with materials to match the original and other materials such as consolidants that are appropriate to the original material. (Consultation with a stained glass specialist is recommended for repairs to art glass.)
- G. New windows on front facades and sides visible from the street shall not have snap-in or flush muntins. True divided muntins are acceptable.
- H. Windows may have screens and/or storm windows. See Screen, Storm and Security Windows Section.
- I. Basement windows should not be enclosed or concealed on the exterior, and masonry should be properly re-pointed when repaired.

Historic buildings display a wide variety of windows in various designs and sizes. These are important features of the various architectural styles. Decorative windows include materials such as stained glass, beveled, leaded glass, and etched glass. Most early windows are made from wood and with proper repair can be made functional. Window openings original to a dwelling shall not be covered or concealed.

New windows may be added at the rear and non-visible sides of a building.

See also, Preservation Briefs:

No. 9: Repairing Historic Wood Windows

No. 13: The Repair and Thermal Upgrading of Historic Steel Windows

No. 33: The Preservation and Repair of Historic Stained and Leaded Glass

Windows

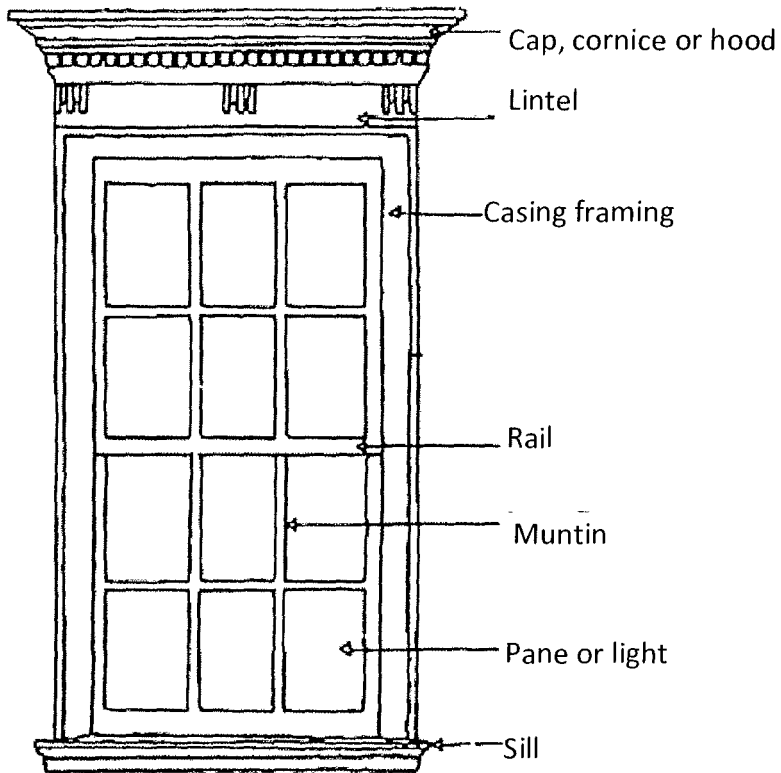

Windows



Appropriate for Greek Revival style

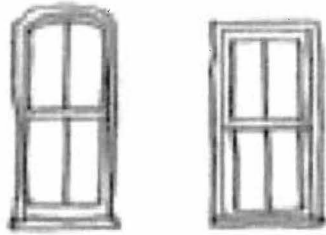

Appropriate for Italianate, 2<sup>nd</sup> Empire, Octagon style

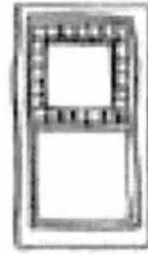

Appropriate for Queen Anne, Stick, Eastlake styles

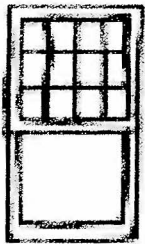

Appropriate for Shingle and Prairie styles

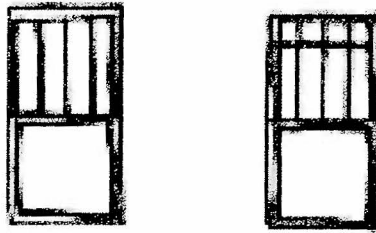

Appropriate for Prairie and Bungalow styles

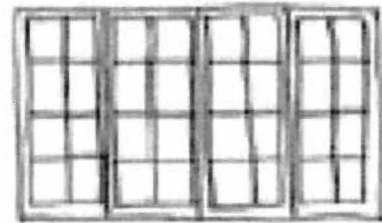

Appropriate for Tudor Revival style

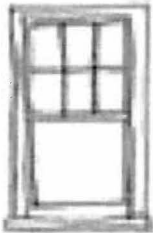

Appropriate for Colonial Revival and Neo-Classical styles

## Siding

Original siding materials are essential components in defining a building's architectural character. The concealment of original wood siding under synthetic sidings is not appropriate. These siding materials do not successfully imitate original wood siding in dimensions or texture. The use of synthetic sidings also poses potential problems for historic buildings. These materials have a limited life span and may not be cost effective compared to continued maintenance and painting of wood siding. Aluminum and vinyl siding which is 15 to 20 years old becomes faded, chipped, or cracked and may require painting. If insulation without a vapor barrier is installed, the interior should be painted with an impermeable paint to prevent moisture condensation in the wall.

- A. Wood siding original to a building shall be repaired rather than replaced. If replacement is necessary, wood siding and shingles shall be replaced with new to match the original in size, placement, and design. If considering the replacement of siding, obtain a determination from the Historic Preservation Commission on the condition of the existing siding. Wood siding original to a dwelling shall not be concealed beneath synthetic materials.
- B. Wood siding that has been concealed beneath synthetic siding should be repaired. Following the removal of synthetic siding, original siding should be repaired to match the original, caulked and painted. When ghosting or outlines of decorative missing features are revealed, these should be replicated and reinstalled. If these features are not replaced the ghosting should be recorded through photographs or drawings for possible future replication.
- C. Walls under wood siding may not be altered with plugholes for the installation of insulation in the walls.
- D. Asbestos shingles that are original to a dwelling should be kept stained or painted. If asbestos shingle siding is deteriorated or poses a health hazard, it may be removed and replaced with wood or other substitute siding. Removal of asbestos siding should follow hazardous material guidelines.

*See also:*

- *Preservation Brief 6: Dangers of Abrasive Cleaning to Historic Buildings and*
- *Preservation Brief 8: Aluminum and Vinyl Siding on Historic Buildings; The Appropriateness of Substitute Materials for Resurfacing Historic Wood Frame Buildings*
- *Preservation Brief 10: Exterior Paint Problems on Historic Woodwork*

Most non-masonry, pre-1945 dwellings are generally of frame construction clad with wood siding in any of a variety of shapes. These include horizontal weatherboard or clapboard siding, drop siding and wood shingles. They were sometimes used in combination.



▪ Lapped board siding



▪ Beveled clapboard siding



▪ Drop siding



▪ Shiplap siding



▪ Rabbeted siding



▪ Tongue-and-groove siding



▪ Board-on-board siding



▪ Board-and-batten siding

*Vertical board siding examples*

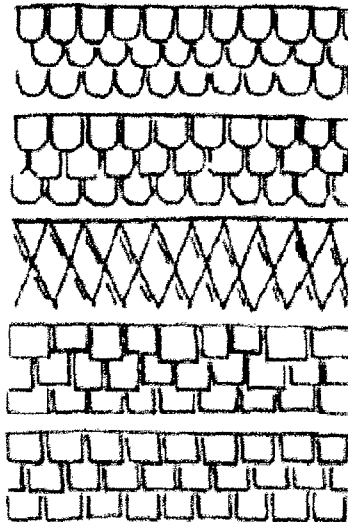

*Wood shingle examples*

**Section II: New Construction Guidelines**

The following section contains guidelines that address appropriate new construction, including additions and new, infill buildings. These guidelines provide important information to insure that the characteristic scale, rhythm, setbacks and massing of the districts are preserved and enhanced.

## Additions

Construction of new residential or commercial additions should be avoided and only done when needed. Additions are acceptable when they are clearly differentiated from the historic building and in such a way not to change, obscure, damage or destroy the character defining features of the historic building.

Additions should be sited at rear or side façades so as not to detract from the primary façade when seen from the street. The design of the additions should have a minimal impact on the building's overall character.

A. Additions should be located at the rear or less visible sides of buildings.

B. Additions shall compliment the original building in size, scale, design, materials, and placement.

C. Additions shall be of a compatible design in keeping with the original building design, roof shape, materials, color, and the location of windows, doors, cornice heights, etc.

D. Additions shall not imitate an earlier historic style or architectural period.

E. Additions shall be compatible with the scale and siting of adjacent buildings located on the same block as well as those on the entire facing block.

F. Additions should be constructed so as not to damage or destroy significant original features, and to avoid removal or loss of historic materials.

G. Additions should minimally impact the exterior walls of the original building, so that the addition could be removed without damage to the basic structure and appearance of the building. Building additions should use existing door and window openings whenever possible for connecting the addition to the building.

H. No portion of an existing building shall be removed, if such removal would destroy important character defining details and features of the building.

I. Additions shall not destroy original landscape elements situated on the building's lot at the primary facades.



- *Appropriate:*  
rear one story addition



- *Appropriate:*  
rear two story addition



- *Inappropriate:*  
side two story addition

See also, *Preservation Brief 14: New Exterior Additions to Historic Buildings*



## Decks

Decks were generally not used prior to 1945 on homes and are not appropriate additions on the front facade or other visible locations of a dwelling. Deck railings should be in forms appropriate to the architectural style of the dwelling. (See section on porches).

More appropriate outdoor sitting areas for back yards of traditional architectural styles are stone or brick terraces or patios next to the house or built under the shelter of a large tree. Summer houses or gazebos especially popular in the latter half of the 19th century; and pergolas, either attached to the house or freestanding, which were popular after the turn of the century may also be an appropriate alternative to a deck.

- A. Decks shall be located at the rear of buildings or areas not visible from the street.
- B. Decks should be stained with an opaque stain (not clear) or painted to blend with the colors of the building. (See Paint Section)
- C. Decks should be kept simple in design. Wood decks with traditional style wood balusters and rails complimentary to the style of the building are recommended. (See Porch Section)

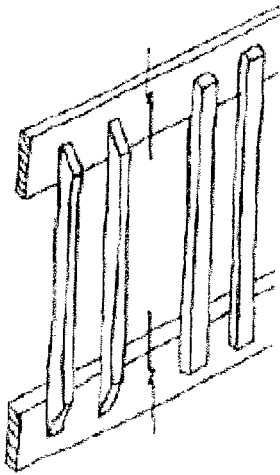

Inappropriate deck rails and balusters

## New Garages and Outbuildings

Secondary buildings include garages, sheds, and other outbuildings. New construction of secondary buildings such as garages and sheds is acceptable as long as they are appropriate in design and sited in traditional locations. Construction materials should be similar to those of the primary dwelling.

A. Secondary buildings shall be smaller in scale than the primary dwelling.

B. Secondary buildings should be built at traditional locations for outbuildings in the locally designated districts. These include at rear lot lines, adjacent to alleys, and at the rear side of a dwelling.



C. Secondary buildings shall be compatible in design, shape, materials, and roof shape with the associated primary building.



D. Exterior materials of secondary buildings should match or be compatible with those of the primary building.

E. For garage doors, wood paneled doors are appropriate. Paneled doors of vinyl, aluminum, or steel are not appropriate. Wood paneled overhead roll-up doors are widely available and are appropriate for new garages.



## Roofline Additions

Roofline additions of dormers can be used to create livable space in attic or upper floors of residential buildings with sloped roofs. It is important when considering a roofline addition to remember the guidelines for additions in general in regards to additions.

Additions that will affect roof forms should be placed so as to minimize their impact as viewed from the street.

Often commercial buildings have a low slope roof that appears flat from the street. Additions to flat roofs should not be visible from grade.

A. Roofs shall not have new dormers, roof decks, balconies or other additions introduced on building fronts unless it is stylistically appropriate. These additions may be added on the rear or sides where not visible from the street.

B. Additions to flat roofs should not be visible from grade.



Dormer addition on rear roof

## Infill Buildings

It is important that new construction in commercial and residential areas compliment the existing buildings. New infill construction should be compatible with the existing, in massing, setback, roof forms, materials, window and door rhythm or placement, and for residential properties, porch location and scale.

Commercial buildings typically extended across the entire lot width and taken together made a single street façade composed of regular rhythm of bays and window openings. When one or more of these lots are vacant, infill construction is encouraged in order to make whole the street façade.

New infill construction should respond to the specific site and setting and maintain the existing pattern of buildings along the block on both sides of the street. The new design should be compatible with the existing context in the following ways:

1. **Site:** the established setbacks, placement on the lot and street orientation
2. **Shape:** the massing of forms of the neighboring properties including roof shape and pitch.
3. **Scale:** the elements of the facade that define the building's scale such as height, roof, windows and doors
4. **Proportion:** rhythm of the lot widths and features including entrances, windows, doors, etc.
5. **Materials**
6. **Color and textures**



Existing pattern of residential building setbacks

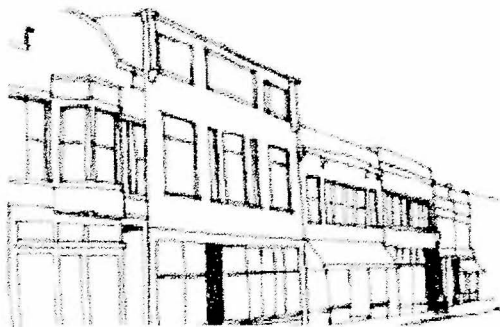

Appropriate commercial infill

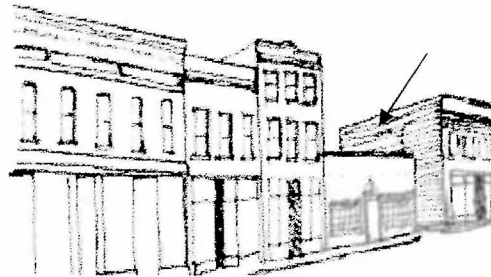

Inappropriate commercial infill

*Infill buildings should appear similar in width to the historic buildings on the block.*

*Traditionally, buildings were built in 20 to 25 foot increments, new buildings should reflect this pattern. Wider buildings should be divided into modules of similar widths.*

### Section III: Site and Setting Guidelines

Kendall County's potential Historic Districts and Historic Landmarks were developed from the mid-19th through the mid-20th centuries. Most blocks in the Districts retain their original character of site and setting. In residential neighborhoods dwellings were built with consistent street setbacks and with front yards for landscaping. Typically, the house's porch and main entrance were oriented towards the street. Blocks were laid out with similar lot dimensions and distances between houses, creating a consistent rhythm and pattern in the location of buildings and the intervening spaces.

In the downtown areas, commercial buildings were laid out and built to form a continuous façade close to the sidewalk. The consistent setbacks and similar lot widths set up the rhythm of the streetscape in these commercial blocks.

These streetscape characteristics in the Districts should be preserved and maintained.

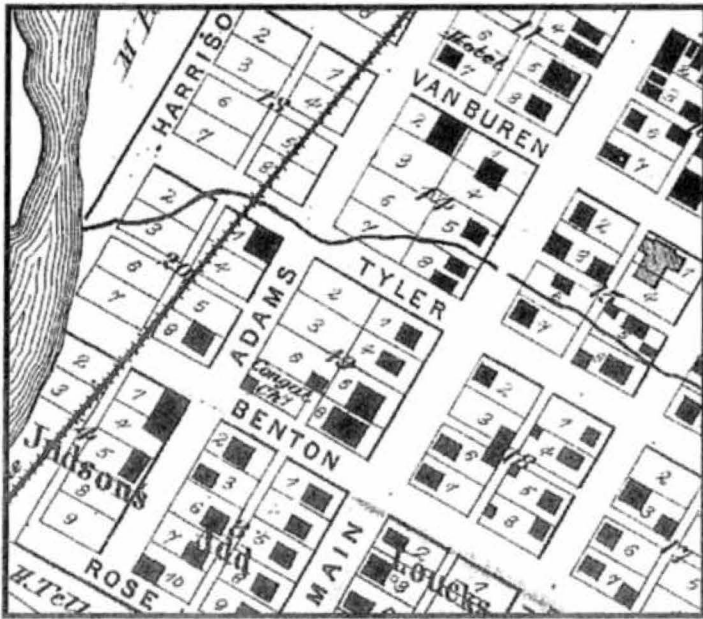

The following guidelines provide information on changes and alterations to a property's site and setting that could affect not only its architectural appearance but also that of the District.

Map excerpt shows consistent setbacks and location of outbuildings at rear lots and along alleys

See also, Preservation Briefs No. 36: Protecting Cultural Landscapes

## Fences and Walls

Wood picket and plank fences and cast iron fences were widely used in residential areas before 1945 to separate lots, outline front yards, and enclose domestic animals and pets. However, few, if any original cast iron fences remain standing.

More recently chain link fences and other designs in wood have become popular but these are non-historic fence materials and are not acceptable.

Historic fences should be preserved and maintained. The construction of new fences based upon historic designs and materials is appropriate.

In addition to the Fence Provisions of the zoning code the following apply.

A. Fences of cast iron or other original materials should be preserved.

B. Fences of cast iron when appropriate to the architectural style of the building may be added.

C. Fences of chain link, poured concrete, concrete block, or wood in basket weave, louver, horizontal board, lattice, stockade or shadowbox designs should not be visible from the street.

D. Walls of free-standing brick are generally not appropriate in front yards but are acceptable at rear yards and side yards not visible from the street.

E. Traditional plantings such as hedges and shrubs are acceptable as alternatives for fences in historic districts.

### Fences in Front and Side Yards

F. Fences of wood pickets or balusters are appropriate for front yards. Such fences shall be painted or stained as appropriate. Pickets or spindles should be no wider than four inches, and be set with top and bottom rails and may have a bottom baseboard.

### Fences in Rear Yards

G. Fences can be constructed in the same low fence design found in the front yard.

H. Fences of wood boards or planks for privacy should be located in rear yards and should be no taller than six feet. Boards should be no more than six inches wide. Privacy fences of flat, vertical boards with flat tops are most appropriate for the historic districts. Vertical boards topped with lattice or pickets are also appropriate.

**Fences and Walls**

Appropriate Front Yard Fences:

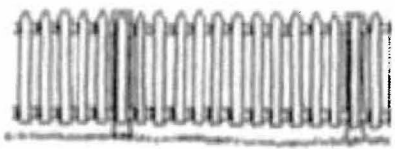

Simple Picket

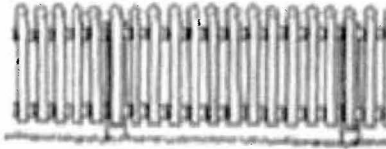

Tulip-top Picket

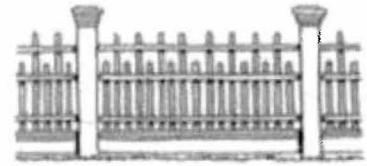

Balusters and spindles

Inappropriate Front Yard Fences:

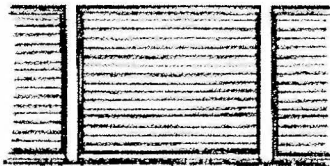

Horizontal board



Horizontal Basket weave

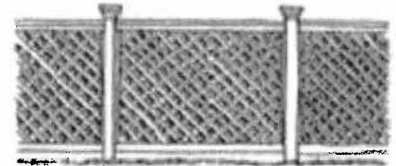

Lattice

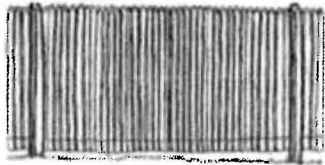

Stockade

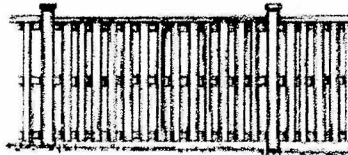

Shadowbox

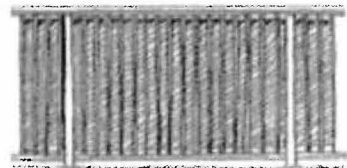

Louver

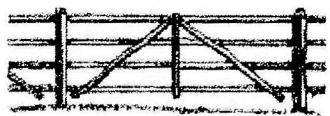

Split-rail with bracing  
(May be appropriate in rural locations)

**Fire Escapes and Secondary Exits**

A. Fire escapes and secondary exits shall not be added unless they are required by fire or safety codes.

B. Fire escapes and secondary exits should be removed when no longer required by code.

C. Fire escapes and secondary exits should be located where they will not be visible from the street.

D. Secondary exits placed on the exterior should be of wood construction with simple balusters and handrails. Metal fire escapes may be installed if they are not visible from the street.

Within municipalities many buildings have been converted into duplexes or apartments. These buildings often have fire escape and/or secondary exits to meet fire and safety codes.

See also, Preservation Briefs No. 32: Making Historic Properties Accessible



## **Landscaping**

Landscape treatments should be appropriate to the era of the building and the district.

Landscape features that were not featured during the historic period of the buildings do not contribute to the overall harmony of the setting.

A. Landscaping designs and materials that reflect the landscape features and plant materials appropriate to the building's period of significance shall be used.

B. Yard areas visible shall have appropriate ground cover; such as lawn or small perennial ground covers.

C. Landscaping plants and materials shall not be placed where limbs and roots will damage historic structures, or prevent water from draining away from the foundation.

D. Areas around trees can be covered with lawn, ground cover, or organic mulch.

E. Ground cover of crushed gravel or aggregate shall not be used except in the immediate areas of downspouts.

F. Larger stones can be used for grade changes, and in the limited areas where traffic inhibits plant growth.

See also, Preservation Brief 36: Protecting Cultural Landscapes

### **Mechanical Equipment, Dumpsters and Other Equipment**

Air conditioning and heating units often require condensers and other mechanical units to be placed within a few feet of the exterior side of a building wall.

Temporary construction dumpsters are exempt from these Guidelines.

A. Ground mounted equipment and dumpsters on the sides of buildings visible from the street shall be screened preferably with shrubbery, but fencing or latticework appropriate to the style of house is also acceptable. Ground mounted heating and cooling units, exhaust fans and dumpsters shall not be located in the front of a building.

B. Mechanical equipment such as gas meters, DBS satellite dishes, and other equipment shall be located on the rear or side of a building not visible from the street.

C. Window air-conditioners, exhaust fans and heat pumps should be located on the rear or sides of dwellings rather than on the front. The installation of such units should not result in the removal or replacement of the original window sash or surround.

D. Additional electrical, telephone, television or computer cables or conduits shall not be attached to the primary facades of a building.

E. Window air conditioners, exhaust fans or heat pumps should not be installed in the primary facades.

## **Parking**

Kendall County was largely platted and developed in the days of horse drawn vehicles and in the early days of the automobile. Some streets were laid out with rear alleys. Garages and carriage houses were generally located directly adjacent to the alleys or in rear yards served by a driveway.

Many of these original early outbuildings were replaced or converted to garages. Today, vehicular access to historic houses is by driveways off the street or through rear alleys.

The addition of garages and parking places in areas other than rear yards is not consistent with traditional streetscape design. Rear yards were not paved for unenclosed parking areas. The intent of these Guidelines is to provide for residential and commercial parking without altering the historic streetscape, or creating situations where historic side and rear yards are eliminated. By limiting the paved areas, damage to historic buildings due to storm water runoff is also mitigated.

A. Front yard areas shall not be paved, covered with blacktop or transformed into an area for surface parking lots. Unpaved areas of a lot shall not be paved without the submission of an acceptable plan approved by the Kendall County Historic Preservation Commission. New parking lots incompatible with the character of the neighborhood shall not be introduced.

B. New off-street parking areas, for residential and commercial properties shall be landscaped around the perimeter of the parking area for screening purposes, and a landscape plan shall be submitted for approval indicating the species, age, and location of the planting material.

C. When existing off-street parking areas are resurfaced, they shall comply with the provisions of the above new off-street parking areas.

D. Driveways shall be limited to a single lane where visible from the street, and allowed to increase towards the rear of the lot where it shall be screened with landscaping or other approved materials. Exceptions are if the driveway was originally two-lane, or if the length does not allow the curvature from one lane to two. The original driveway design, material, and placement, where known, should be preserved.

E. Driveways in the front or side yard should be of brick, concrete, or concrete tracks (two parallel narrow strips of concrete with grass in between - also called "ribbon drives"). Asphalt and textured concrete designed to look like brick pavers are also appropriate materials.

F. Driveways shall not be poured closer than six inches to foundation walls as it causes damage to foundations and walls.

G. Driveway approaches shall be limited to single lane widths to increase the parkway landscaping. Widths at sidewalks shall not exceed 10 feet, and the taper to the road shall not exceed 14 feet.

See also, Preservation Brief 36: Protecting Cultural Landscapes

## **Ramps for Accessibility**

Historic buildings often need to be accessible to the handicapped. Accessibility achieved with the least alteration to important historic features is most appropriate.

A. Ramps should be added so that minimal original historic materials are removed and that the ramp construction is reversible.

B. Ramps should be located at the rear or sides of dwellings. If a ramp is placed on the front of a building it should be of wood construction rather than of brick, concrete, or metal. Brick, concrete, and metal ramps are more acceptable at rear and sides of buildings with interior lots.

C. Ramps should be of simple traditional design and configuration or designed to match the original porch railing in materials, dimensions, and detailing. Ramps should be painted to match the color of the porch railing or to match the overall paint color of the building.

D. Ramps in visible areas should be screened with landscaping.

E. When required by code, ramps shall adhere to applicable historic preservation provisions of the accessibility code.



*Ramp Addition to a porch*

See also, Preservation Briefs No. 32: Making Historic Properties Accessible

## **Sidewalks and Walkways**

Sidewalks and walkways in historic districts are primarily of concrete construction. Many of these were poured in the early 20th century and remain in good condition. The use of concrete is appropriate in the repair, replacement and addition of concrete sidewalks and walkways.

A. Sidewalks and walkways that are original to a dwelling or block should be preserved and maintained.

B. New sidewalks and walkways in the front and side yards that are installed shall match the original in details, dimensions, and placement.

C. Sidewalks and walkways of aggregate or pebble-surfaced concrete are, in most cases, not appropriate in visible areas. Smooth poured concrete, stone, brick pavers, or pavers that replicate brick, properly laid, may be used.

D. Sidewalks and walkways of asphalt shall not be installed in front yards but may be used in areas not visible from the street.

See also, Preservation Brief 36: Protecting Cultural Landscapes

**Swimming Pools, Fountains, Gazebos and Pergolas**

A. Swimming pools should be located in rear or side yards and screened from street view with fencing and/or landscaping. (See Fences and Landscaping.)

B. Arbors and pergolas unless original to the design shall not be installed on primary façades. Arbors and pergolas shall not obstruct character defining elements on primary or side facades visible from street.

C. Accessory buildings, including unenclosed gazebos shall not be allowed in front yards. These may be allowed in side or rear yards. The design and architectural details of the gazebo should be appropriate to the architectural style of the primary structure. See Porch section for guidelines of appropriate gazebo styles.

D. Fountains or water features are acceptable in rear and side yards. Screening must be used if visible from the street.



\* appropriate: simple, unenclosed gazebo

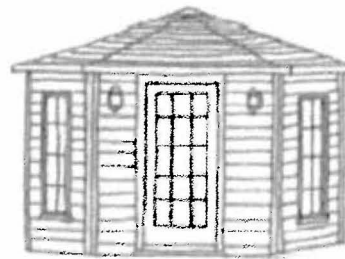

\* Inappropriate: enclosed gazebo

Secretary of the Interior's Standards

1. A property shall be used for its historic purpose or be placed in a new use that requires minimal change to the defining characteristics of the building and its site and environment.
2. The historic character of a property shall be retained and preserved. The removal of historic materials or alteration of features and spaces that characterize a property shall be avoided.
3. Each property shall be recognized as a physical record of its time, place, and use. Changes that create a false sense of historical development, such as adding conjectural features or architectural elements from other buildings, shall not be undertaken.
4. Most properties change over time; those changes that have acquired historic significance in their own right shall be retained and preserved.
5. Distinctive features, finishes, and construction techniques or examples of craftsmanship that characterize a property shall be preserved.
6. Deteriorated historic features shall be repaired rather than replaced. Where the severity of deterioration requires replacement of a distinctive feature, the new feature shall match the old in design, color, texture, and other visual qualities and, where possible, materials. Replacement of missing features shall be substantiated by documentary, physical, or pictorial evidence.
7. Chemical or physical treatments, such as sandblasting, that cause damage to historic materials shall not be used. The surface cleaning of structures, if appropriate, shall be undertaken using the gentlest means possible.
8. Significant archeological resources affected by a project shall be protected and preserved. If such resources must be disturbed, mitigation measures shall be undertaken.
9. New additions, exterior alterations, or related new construction shall not destroy historic materials that characterize the property. The new work shall be differentiated from the old and shall be compatible with the massing, size, scale, and architectural features to protect the historic integrity of the property and its environment.
10. New additions and adjacent or related new construction shall be undertaken in such a manner that if removed in the future, the essential form and integrity of the historic property and its environment would be unimpaired.

## Section IV     Agricultural Structures and Farmsteads

The following approaches should be observed when carrying out rehabilitation projects on historic barns and agricultural outbuildings.

1. Preserve the historic setting of the barn as much as possible. Modern farming practices do not require the great number of outbuildings, lots, fences, hedges, walls and other elements typical of historic farms. Yet such features, together with fields, woods, ponds, and other aspects of the farm setting can be important to the character of historic barns. The functional relationship between the barn and silo is particularly significant and should also be maintained.
2. Repair and repaint historic siding rather than cover barns with artificial siding. Siding applied over the entire surface of a building can give it an entirely different appearance, obscure craft details, and mask ongoing deterioration of historic materials underneath. The resurfacing of historic farm buildings with any new material that does not duplicate the historic material is never a recommended treatment.
3. Repair rather than replace historic windows whenever possible, and avoid "blocking them down" or covering them up. Avoid the insertion of numerous new window openings. They can give a building a domestic appearance, radically altering a barn's character. However, if additional light is needed, add new windows carefully, respecting the size and scale of existing window openings.
4. Avoid changing the size of door openings whenever possible. Increasing the height of door openings to accommodate new farm machinery can dramatically alter the historic character of a barn. If larger doors are needed, minimize the visual change. Use new track-hung doors rather than oversized rolled steel doors, which give an industrial appearance incompatible with most historic barns. If the barn has wood siding, the new doors should match it. If historic doors are no longer needed, fix them shut instead of removing them and filling in the openings.
5. Consider a new exterior addition only if it is essential to the continued use of a historic barn. A new addition can damage or destroy historic features and materials and alter the overall form of the historic building. If an addition is required, it should be built in a way that minimizes damage to external walls and internal plan. It should also be compatible with the historic barn, but sufficiently differentiated from it so that the new work is not confused with what is genuinely part of the past.
6. Retain interior spaces and features as much as possible. The internal volume of a barn is often a major character-defining feature, and the insertion of new floors, partitions, and structures within the barn can drastically impair the overall character of the space. Similarly, interior features should also be retained to the extent possible.
7. Retain as much of the historic internal structural system as possible. Even in cases where it is impractical to keep all of the exposed structural system, it may be possible to keep sufficiently



extensive portions of it to convey a strong sense of the interior character. Wholesale replacement of the historic structural system with a different system should be avoided.

See also, Preservation Brief No. 20: Preservation of Historic Barns

Section V      Commercial Centers and Storefronts- To be added at a later date

Section VI      Signage- To be added at a later date

Section VII Demolition and Removal- To be added at a later date